

TOTO

Head Office

TOTO Europe GmbH
Zollhof 2, 40221 Düsseldorf Germany
Tel:+49 (0)700 8686 0700

TOTO

WASHLET

Instruction Manual



washlet

TCF802C2G
TCF801CG

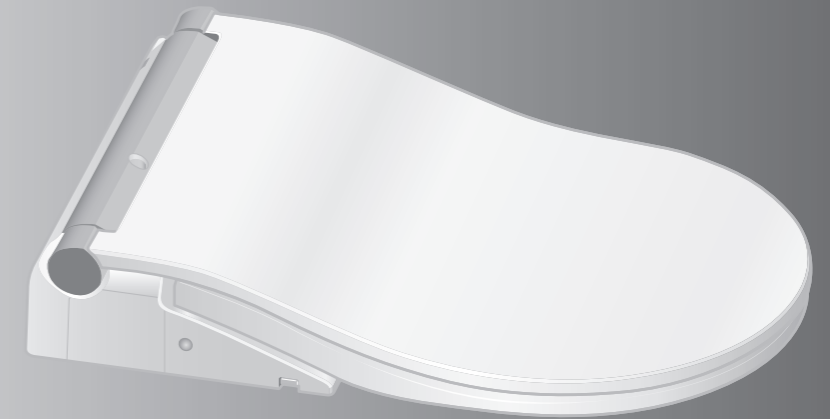

You are advised to record the following information to allow quick service.

Date of purchase :	Name of shop :
Date : year month day	
	Tel :

- Thank you for your recent purchase of this product.
Please read the enclosed information to ensure the safe use of your product.
- Be sure to read this Instruction Manual before using your product and keep it in a safe place for future reference.

The available functions vary according to the part no.

Check your model's part no. and write a check mark in this field as needed.

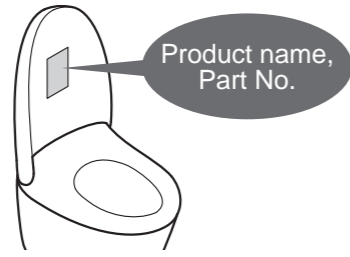

Functions		Product name (Model)	WASHLET		Ref. Page	
		Part No.	TCF802C2G	TCF801CG		
		Your Model				
Basic Functions	Cleansing	Rear cleansing			14, 15	
		Rear soft cleansing	●	●		
		Front cleansing				
	Changing the cleansing method	Wand position adjustment				
		Water pressure adjustment				
		Oscillating cleansing	●	●		
		Pulsating cleansing				
	Drying	Warm air drying	●	●		
	Changing the temperature	Temperature adjustment	●	●		22, 23
	Sanitary Functions	Removing odours	Deodorizer	●		●
"ewater+" cleaning		Auto wand CLEAN	●	●		
		Auto bowl CLEAN	●	●		
Convenience Functions	Flushing	Remote control flushing	●	—	14	
		Auto flushing	●	—	20, 21	
	Opening and closing	Opening and closing the toilet seat with remote control	●	●	14	
		Auto open / close			20, 21	
	Lighting up	Soft light	●	●		
	Heating the toilet seat	Heated seat	●	●	—	
	Save energy by lowering the toilet seat temperature	Auto energy saver			24, 25	
Auto energy saver+		●	●			
Timer energy saver						
Maintenance	Main Unit One-touch removal				32, 33	
	Removable toilet lid		●	●	34	
	Wand cleaning				30	
	Descaling mode				35	

Keep It Clean Sanitary Toilet



The self-cleaning functions operate automatically. (See pages 18,19 for details.)

	As you approach	As you sit	As you stand up
Removing odours inside the bowl unit		Deodorizer	Auto power deodorizer
Cleans the bowl unit with "ewater+"	Auto bowl CLEAN		Auto bowl CLEAN
Cleans the wand with "ewater+"			Auto wand CLEAN

Table of Contents

Safety Precautions	4	Introduction
Operational Precautions	9	
Parts Names	10	
Preparation	12	
Basic Operations	14	Operation
Automatic Functions (Cleaning Features)	18	
Deodorizer, Auto wand CLEAN, Auto bowl CLEAN, Bowl light, CLEAN Indicator		
Automatic Functions (Convenience Features)	20	
Auto flushing, Auto open/close, Soft light		
Temperature Adjustment (Warm Water, Toilet Seat, Drying) ..	22	
Energy Saver Features	24	
Maintenance	28	Maintenance
● Main Unit	29	
● Wand	30	
Wand cleaning		
● Deodorizing Filter	31	
● Gap between the Main Unit and Bowl Unit	32	
● Gap between the Main Unit and the Toilet Lid	34	
● Descaling mode	35	
● Water Filter Drain Valve	40	
● Spray Nozzle	41	
Changing Settings	42	
What to Do?	62	
● If the water does not flow due to a water service interruption	62	
● If you cannot operate with the remote control	62	
● Freeze Damage Prevention	63	
● Long Periods of Disuse	64	
● Removal of Operation Guide	66	
Troubleshooting	67	
Specifications	74	
Safety Guidelines	75	
Warranty	76	
Important User Guidance Information	78	

Introduction

Operation



Maintenance

Reference



Safety Precautions

These precautions are important for safe usage. Be sure to follow them and use the product correctly.



Symbols and Meanings



	WARNING May result in death or serious injury.
	CAUTION May result in injury or property damage.

The following symbols are used to indicate important safety instructions for the use of the product.

Symbol	Meaning
	This symbol indicates a prohibited use of the product.
	This symbol is used to indicate a required step in the use of this product.



- This product is classified as Class I Equipment and must be grounded.
- Install this equipment so that its power breaker is accessible.
- This appliance is not intended for use by persons (including children) with reduced physical, sensory or mental capabilities, or lack of experience and knowledge, unless they have been given supervision or instruction concerning use of the appliance by a person responsible for their safety. Children should be supervised to ensure that they do not play with the appliance.
- Use the new hose set included with this equipment. Do not reuse an old hose set.

 WARNING	
	<p>Do not touch the connection of power cord with wet hands.</p> <ul style="list-style-type: none"> • Doing so may cause electrical shock.
	<p>Do not get any water or cleaning solution on the main unit or connection of power cord.</p> <ul style="list-style-type: none"> • Doing so may cause fire, electrical shock, heat or short circuit. • Doing so may cause the product to crack resulting in injury or water damage.
	<p>Never disassemble, repair or alter.</p> <ul style="list-style-type: none"> • Doing so may cause fire, electrical shock, overheating, short circuit or breakdown.
	<p>Do not install the product on moving vehicles such as wheeled vehicles or boats.</p> <ul style="list-style-type: none"> • Doing so may cause fire, electric shock, short circuit or malfunction. • The toilet seat, toilet lid, main unit, or other parts may come loose and fall off, resulting in injury.

 WARNING	
	<p>Do not use the product if a malfunction occurs.</p> <ul style="list-style-type: none"> • In case of breakdown or other problems, be sure to cut off power by flipping the power switch to OFF. Close the water shutoff valve to stop water supply. Possible malfunctions: <ul style="list-style-type: none"> – Water is leaking from a pipe or the main unit. – The product is cracked or broken. – The product makes a strange noise or emits a strange odor. – The product emits smoke. – The product is abnormally hot. – The toilet seat cushion is out of place. • Continued use after malfunction could cause a fire, electric shock, heat, short circuit, injury or water damage.
	<p>Do not use other water than allowed by the laws and ordinances of the region of use. Only Use drinking water.</p> <p>Do not use seawater or recycled water.</p> <ul style="list-style-type: none"> • Doing so may cause irritation to the skin and malfunction.
	<p>Do not touch the connection of power cord during thunderstorms.</p> <ul style="list-style-type: none"> • Doing so may cause electrical shock.
	<p>Do not allow the water supply hose to touch the connection of power cord.</p> <ul style="list-style-type: none"> • Doing so may cause condensation resulting in a fire, electrical shock, heat or a short.
	<p>Do not do anything that may damage the power cord.</p> <p>Do not strike, yank, twist, excessively bend, damage, alter, or heat the power cords.</p> <p>Also, do not place anything heavy on, bind or pinch the power cords.</p> <ul style="list-style-type: none"> • Using a damaged power cord may result in a fire, electrical shock, heat or short.
	<p>Do not use any power supply other than the one specified.</p> <p>AC 220-240 V, 50 Hz</p> <ul style="list-style-type: none"> • Doing so may cause fire or excessive heat.
	<p>To reduce the danger of burns, death from electric shock, fire or other human injury:</p> <ul style="list-style-type: none"> – Never operate this product if it has a damaged power cord or power connecting part, if it is not working properly, if it has been dropped or damaged, or if it has been dropped in water. Return the product to TOTO Europe GmbH for examination and repair. – Never block the air openings of the product or place it on a soft surface, such as a bed or a couch, where the air openings could be blocked. Keep the air openings free of lint, hair or a similar material. – Never use it while sleepy or drowsy. – Never drop or insert anything into any opening or hose. – Do not use it outdoors where aerosol (spray) products are being used or where oxygen is being administered.
	<p>Do not stick a finger or anything else into the warm air outlet.</p> <p>Do not place anything on the warm air outlet or drape clothes over it.</p> <ul style="list-style-type: none"> • Doing so may cause burns, electrical shock or malfunction.

Safety Precautions (Continued)

WARNING

	<p>Keep cigarettes and other open flames away from the product.</p> <ul style="list-style-type: none"> • Failure to do so may cause fire. <p>Refrain from sitting on the seat for long periods.</p> <ul style="list-style-type: none"> • It may cause low-temperature burns. <p>To prevent the following persons from getting a moderate temperature burn during use, other person should turn off the toilet seat heater.</p> <ul style="list-style-type: none"> – Young children, the aged and other users unable to set the temperature appropriately themselves. – The ill, physically disabled and others who do not have freedom of movement. – Those using any medicines that cause drowsiness (sleeping or cold medicine), those who have been drinking heavily, anyone severely fatigued and anyone else liable to fall asleep. <p>Do not cut the string that connects the main unit and base plate.</p> <ul style="list-style-type: none"> • Doing so may cause fire, electrical shock, overheating, short circuit or breakdown.
	<p>To reduce the danger of burns, death from electric shock, fire or other human injury:</p> <ul style="list-style-type: none"> – Close supervision is necessary when this product is used by or near children or invalids. – Use this product only for its intended use as described in this manual. Do not use accessories not recommended by the manufacturer. – Keep the power cord away from heated surfaces. – Connect this product to a properly grounded the power supply unit (device) only. – The tank should only be filled with water. <p>This is an electrical product. Do not install it anywhere water is likely to get on the product or anywhere with humidity high enough that water is likely to form on the surface of this product. When using the product in a bathroom, install a fan or ventilation port and ensure good air flow through the bathroom.</p> <ul style="list-style-type: none"> • Failure to do so may cause fire or electrical shock. <p>Always connect the product to the cold water supply.</p> <ul style="list-style-type: none"> • Connecting to hot water supply may result in burns and equipment damage. <p>Check that the power cord is connected correctly.</p> <ul style="list-style-type: none"> • Failure to do so may cause fire, heat or short circuit. <p>(When installing this product, observe the local laws and regulations regarding installation.)</p> <p>If the power cord is damaged, avoid danger by having the manufacturer's repair department or equivalent specialist replace it.</p> <p>Always flip the power switch to OFF before maintenance or inspection.</p> <ul style="list-style-type: none"> • Failure to do so may cause electrical shock or malfunction. <p>Flip the power switch to "OFF" before removing the main unit.</p> <ul style="list-style-type: none"> • Failure to do so may cause a fire or electrical shock. <p>When leaking battery fluid adheres to your body or clothes, wash it away with clean water.</p> <ul style="list-style-type: none"> • The fluid may damage your eyes or skin.

CAUTION

	<p>Do not use the product if the main unit is unstable.</p> <ul style="list-style-type: none"> • Doing so may cause the main unit to come loose and fall, resulting in injury. <p>(If there is backlash in the main unit, consult the installer, seller, or TOTO customer service. See contact information on the back cover.)</p> <p>If the product is damaged, do not touch the damaged section.</p> <ul style="list-style-type: none"> • Doing so may cause electrical shock or injury. <p>Replace it immediately.</p> <p>Do not apply strong force, mechanical shock, step on or stand on the toilet seat, toilet lid or main unit. Also do not place any heavy object on the toilet seat, toilet lid or main unit.</p> <ul style="list-style-type: none"> • Doing so may cause cracking or cause the main unit to come loose and fall, resulting in injury. • Doing so may damage the product and cause injury or water damage. <p>Do not lift up this product by the toilet seat or lid.</p> <p>Do not raise the toilet seat or lid while objects are resting on top of the unit.</p> <ul style="list-style-type: none"> • Doing so may cause the main unit to come loose and fall, resulting in injury. <p>To reduce the danger of death from electric shock:</p> <ul style="list-style-type: none"> – Do not use while bathing. – Do not place or store the product where it could fall or be pulled into a tub or sink. – Do not put in or drop into water or other liquid. – Do not try to recover the product if it has fallen into water. <p>Switch the breaker on the distribution board to OFF.</p> <p>When maintaining the plastic parts (main unit etc.) or the water supply hose, use a neutral kitchen detergent diluted with water. Do not use any of the following.</p> <p>Toilet cleaner, household cleaner, benzene, paint thinner, powdered cleanser or nylon scrubbing brush.</p> <ul style="list-style-type: none"> • These items may damage or crack the plastic and cause injury or malfunction. • These items could damage the water supply hose and cause a water leak. <p>To prevent a sudden water leak, do not remove the water filter drain valve when the shutoff valve is open.</p> <ul style="list-style-type: none"> • Doing so will cause water to spurt out. <p>(Refer to Page 40 for instructions on cleaning the water filter drain valve.)</p> <p>Do not fold or crush the water supply hose; do not damage by cutting with a sharp object.</p> <ul style="list-style-type: none"> • Doing so may cause water leaks. <p>Do not install the base plate, which is not attached.</p> <ul style="list-style-type: none"> • Doing so may cause damage.
---	--

Safety Precautions (Continued)

⚠ CAUTION

If a water leak should occur, always close the shutoff valve.

When the ambient temperature is likely to drop to 0 °C or lower, prevent damage to the pipes and hoses due to freezing.

- Frozen water pipes could cause the main unit and the pipes to break, resulting in a water leak.
- Regulate the room temperature to prevent the pipes and hoses from freezing during cold months.
- Drain the water.

When not using the product for a long time, close the shutoff valve, drain the water from the main unit and water supply hose, and then flip the power switch to "OFF".

- When using the product again, allow the product to refill with water first. Otherwise, the water in the tank might become contaminated and cause skin inflammation or other problems. (Refer to Page 65 for instructions on replenishing the water.)
- Leaving the power on may cause fire or heat.

When installing the water filter drain valve, make sure that it is securely tightened in its proper position.

- Failure to securely tighten it may cause a water leak.

If the bowl unit is clogged, flip the power switch to OFF and remove the clog.

- If the "Auto flushing"^{*1} is activated, it would make the wastewater in the bowl unit overflow and may result in water damage.
- Use commercially available tools that are made for unclogging the bowl unit to remove the clogging.

Push the main unit securely on to the base plate.

- After pushing the main unit until a click sound is heard, pull it slightly toward you to make sure that the product does not detach.
- Failure to do so could cause the main unit to come loose resulting in injury.

Make sure of the plus and minus signs on the batteries before inserting them.

Remove depleted batteries immediately.

When replacing the batteries:

- **Replace both batteries with new ones.**
- **Use the same brand for both new batteries (any brand available).**
- Failure to do so may cause the batteries to leak fluid, generate heat, rupture, or ignite.

When the product is supposed not to be used for long time, remove the batteries from the remote control.

- Failure to do so may cause the batteries to leak fluid.

Operational Precautions

■ For prevention of malfunctions

- Do not block the body sensor or the remote control transmitter or receiver.

< About the body sensors >

Two types of body sensors are used.

- **Body sensor A detects changes in heat.**
 - Detection may be difficult when the room temperature exceeds 30 °C, such as in the summertime.
 - When sunlight is directly on the sensor area or a heater is used in the bathroom, the sensor may detect incorrectly due to the heat, resulting in the automatic operation of functions such as auto lid opening and closing.
 - When the bathroom door is open, the sensor may detect people who pass to the front or side of the toilet.
- **Body sensor B detects when someone stands in front of the toilet bowl.**

- Body sensor B emits an infrared beam as shown in the figure. When someone moves into the line of this infrared beam, the sensor detects the person.

* Detection by the sensor may be difficult when the toilet is used by someone small, such as a child.

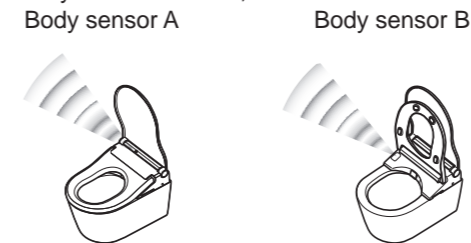

■ About the built-in seat sensor

When you sit on the toilet seat, the seat sensor turns ON, enabling you to use various features. (The deodorizer starts when the seat sensor makes a detection.)

- Sit so your skin is in direct contact with the seat sensor. The seat sensor may not detect properly if there is a seat cover or clothing.
- Water droplets collecting on the seat sensor may cause the main unit to malfunction. Be sure to wipe off any water droplets on the sensor.

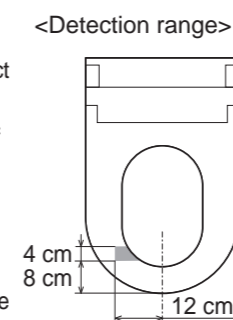

■ For prevention of damage

- Wipe plastic areas such as the main unit and remote control with a soft cloth tightly wrung out with water.
- Do not lean against the toilet lid.

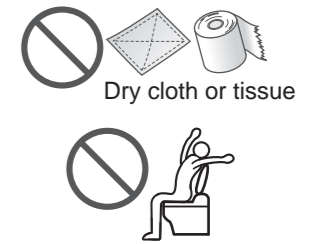

■ For prevention of malfunctions and failures

- Flip the power switch to OFF if there is a risk of lightning.
- A toilet seat cover or a toilet lid cover cannot be used. (The seat sensors may not function properly. Additionally, the toilet seat and lid may not open or close properly.)



- Do not urinate on the main unit, toilet seat or wand. (Doing so may cause a failure or discoloration.)
- Do not apply strong forces to the control panel of the remote control.
- When using a toilet cleaner to clean the toilet, rinse it off within 3 minutes and leave the toilet seat and toilet lid open. (If vapor from a toilet cleaner enters the main unit, it may cause a malfunction.)
 - Wipe off any cleaner that remains on the bowl unit.
- Do not use the product with the toilet lid removed.
- Do not expose to direct sunlight. (Doing so may cause changes in color, irregular heated seat temperature, remote control malfunction or the product malfunction due to the change in temperature.)
- Use radios, etc. away from the product. (The product could cause interference with the radio signal.)
- If you use a booster seat for infants or a soft highchair, remove it after use. (Keeping it installed may prevent some of the functions from being used.)
- Do not apply force to the remote control. (May cause malfunction.)
 - To prevent the remote control from being dropped, set it in the hanger when you are not using it. Be careful not to expose it to water.
- Do not place anything on top of the toilet seat. Additionally, do not press it by hand. (Doing so may activate the seat sensor, causing the floor to get wet if buttons on the remote control are touched and warm water comes out from the wand.)

About rear cleansing, rear soft cleansing and front cleansing

- **These functions wash away waste and dirt from a localized area of your body.**
- **Do not cleanse too much or for too long.** Doing so may wash away normal bacteria, upsetting the balance of bacteria inside your body.
- **People who are receiving medical treatment or therapy in this localized area should consult their doctor before use.**

*1 Only applies to toilets with an "Auto flushing" function

Parts Names

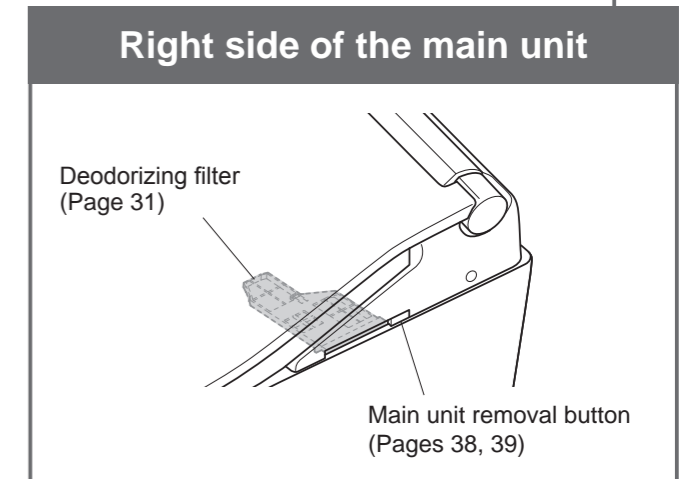
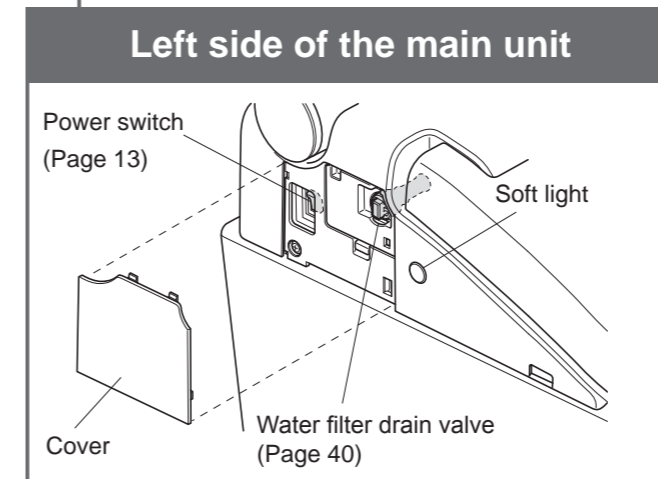
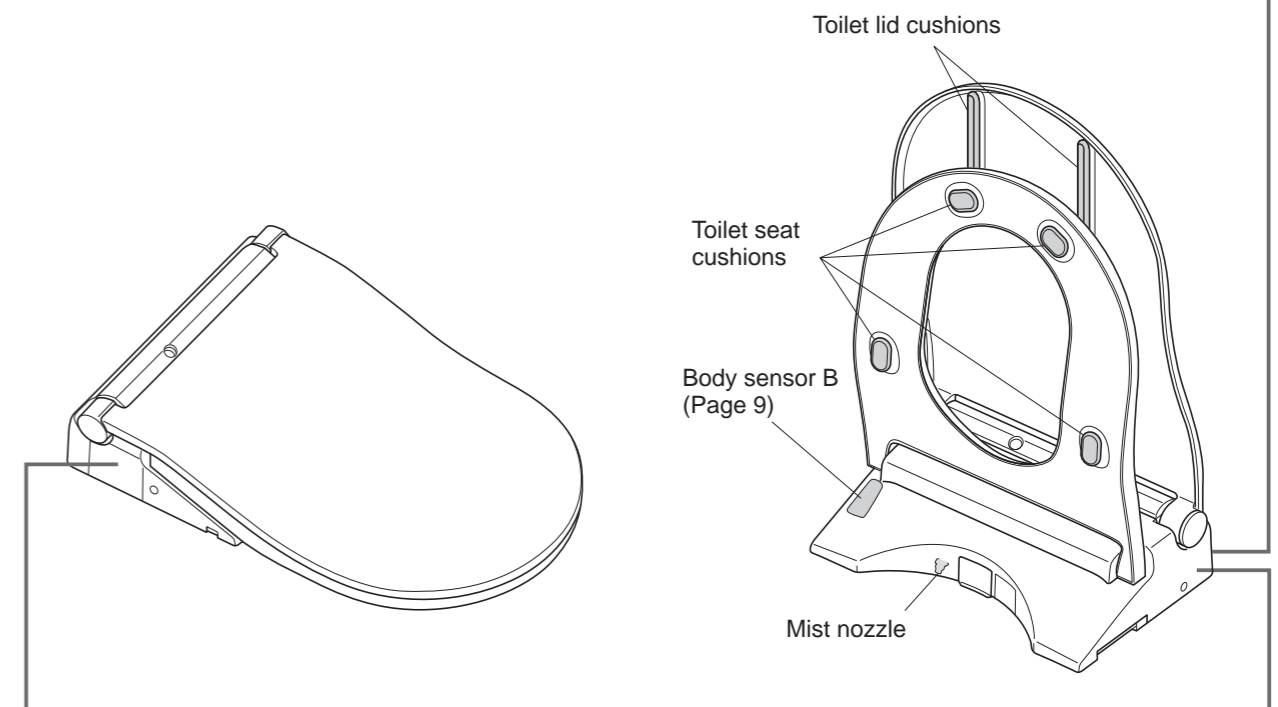
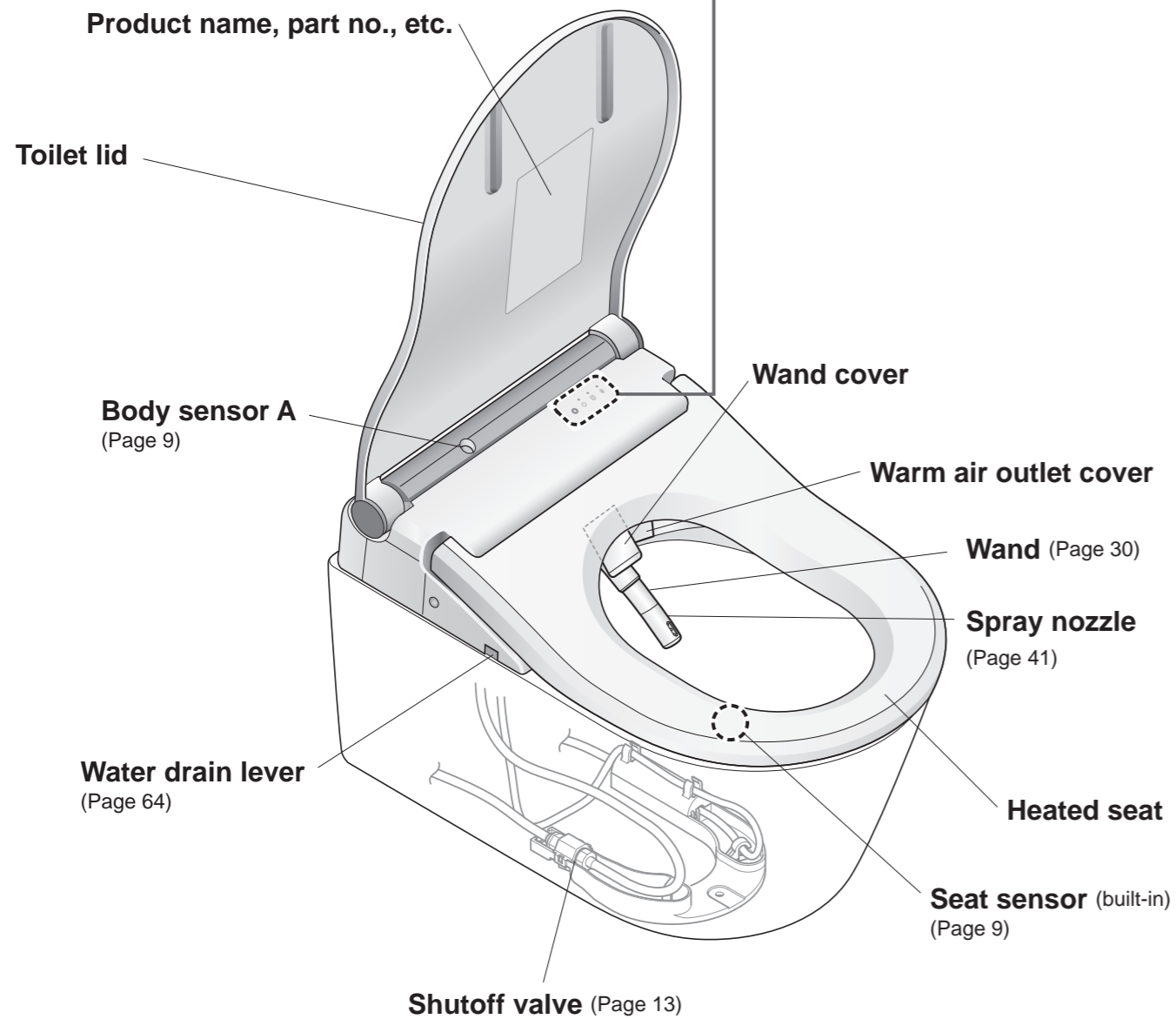
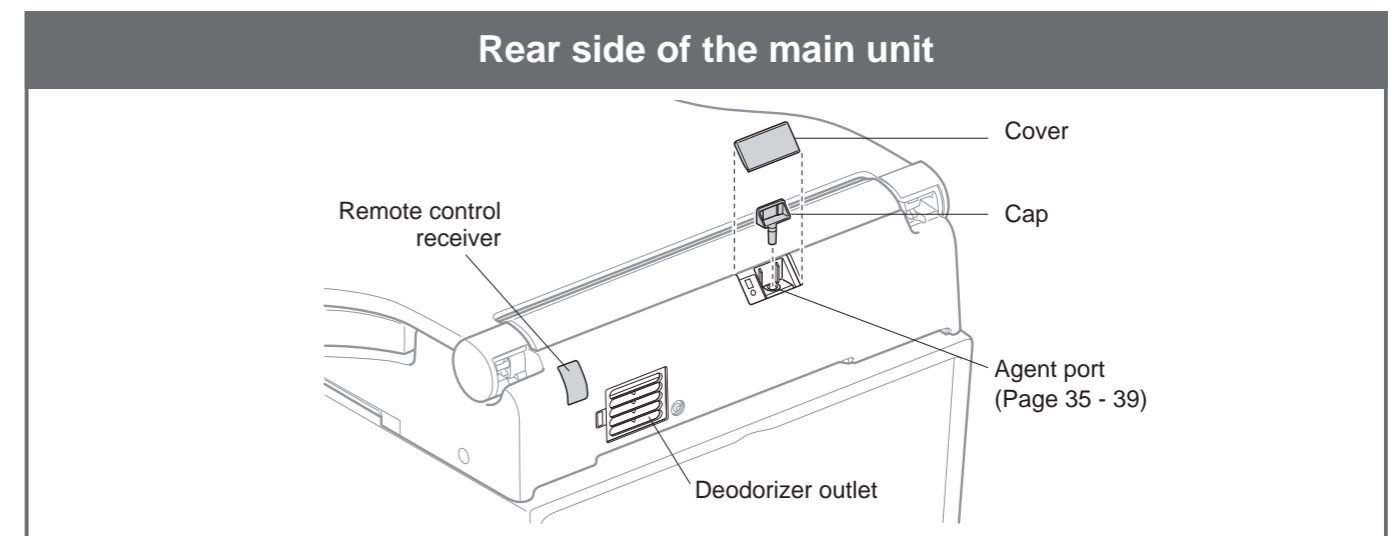
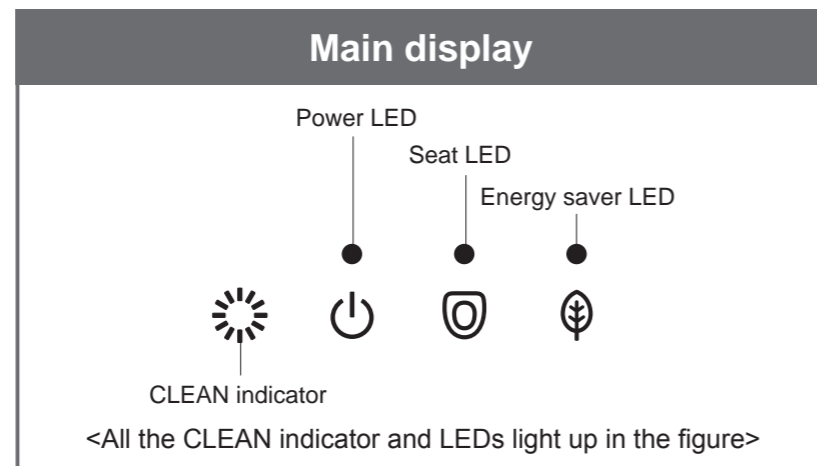

Descriptions in this manual are based on the illustrations of TCF802C2G.

1. Insert the battery

- 1** Remove the remote control from the hanger.

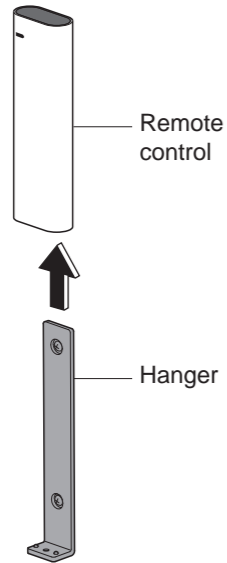

- 2** Open the battery cover and insert two AA batteries.

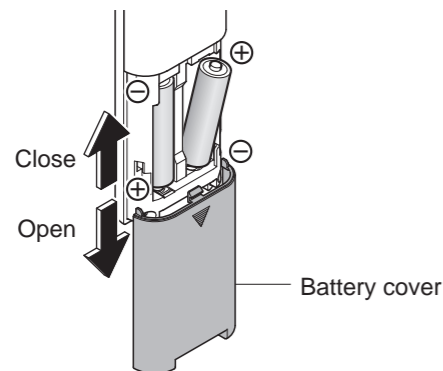

- When batteries are properly inserted, temperature levels appear on the display of the remote control (back side).
→ When the temperature levels are not displayed, perform step 3 of "Language Settings" in page 56.
- The display goes out when no button on the remote control is pressed for about 60 seconds or more.

- 3** Mount the remote control in the hanger.

■ About the batteries

- Use dry cell, alkaline batteries.
- Be sure to follow "Safety Precautions" to prevent the batteries from rupturing or leaking fluid. (Pages 6, 8)

If the remote control is secured (for anti theft)

- 1** Remove the screw from the remote control fixture.

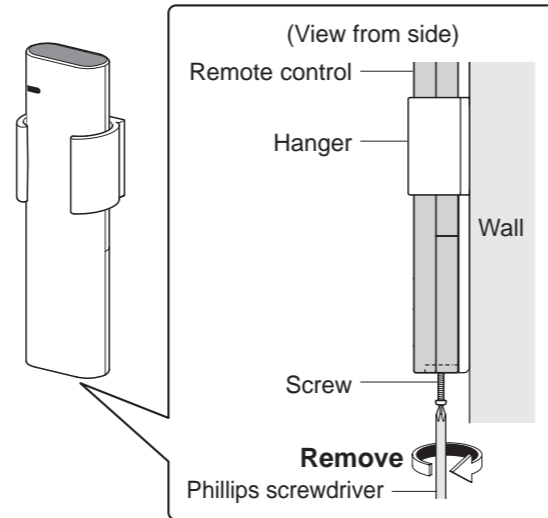

- 2** Remove the remote control from the hanger.

■ To secure the remote control again

- Tighten and fix the screw.
(Overtightening may cause damage to parts such as the hanger.)

2. Turn on the power

- 1** Switch the breaker on the distribution board to ON.
• The wand extends and then retracts.
- 2** Check that the "Power" LED lights up.

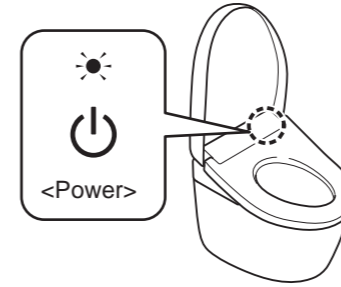

<If the light is off>

- (1) Remove the cover on the left side of the main unit, and flip the power switch to ON.

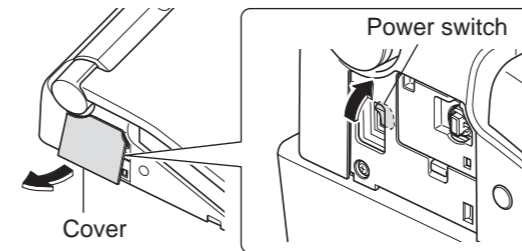

- (2) Reinstall the cover. (Page 29)

<If the light is off but, the power switch is "ON">
• Switch "Power" to "ON" using the remote control.

To operate from the back of remote control

- ⏻ Press "Power ON/OFF" button about 3 seconds or longer.

To operate from the front of remote control

- Recommended if the remote control is secured to prevent theft.
- ⚡ Press "Oscillating cleansing" button about 10 seconds or longer.

To turn the power "OFF"

Remove the cover on the left side of the main unit, and flip the power switch to "OFF".

- The "Power" LED goes off.

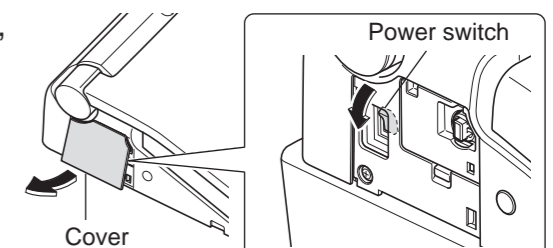

3. Open the shutoff valve

- 1** Fully open the shutoff valve.

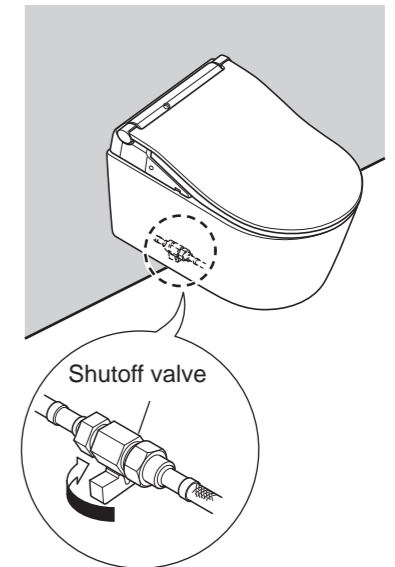

Basic Operations

Operate the controls on the remote control; a beep sounds when the main unit receives the signal.

● Functions that operate when a button is pressed during "Rear cleansing", "Rear soft cleansing" or "Front cleansing".

Note
● Sitting back on the toilet seat makes it easier to adjust the wand position and to reduce splashing.

"Oscillating cleansing"
The wand moves back and forth to cleanse your rear thoroughly.
● The setting changes between "ON" and "OFF" each time the button is pressed.

"Pulsating cleansing"
Cleanses with the water pressure pulsating between soft and strong.
● The setting changes between "ON" and "OFF" each time the button is pressed.

"Wand CLEAN"
Cleans the wand with "ewater+".
● The wand can be automatically cleaned when you use the cleansing functions (Rear cleansing, Front cleansing, etc.). (Page 18)

Flushing *1

- "Full flush"**
Performs a full flush.
- "Light flush"**
Performs a light flush.

Opening and closing

- "Opening and closing the toilet seat"**
Opens and closes the toilet seat.

Note
When setting Auto open/close to "OFF".

- The toilet lid opens/closes when you press the button.
- Press the button for longer than 1 second to open/close the toilet seat.

Stopping

- "Stopping"**
Stops the operation.

Cleansing

- "Rear cleansing"**
Cleanses your rear.
- "Rear soft cleansing"**
Cleanses your rear with mild water pressure.

● The setting changes between and each time the is pressed.

- "Front cleansing"**
Serves as a bidet for ladies.

Drying

- "Warm air drying"**
Dries your rear.

● The "Water pressure adjustment", "Wand position adjustment" and "Personal setting" functions are swipe operated.

● Functions that operate when a button is pressed during "Rear cleansing", "Rear soft cleansing" or "Front cleansing".

Note

● Sitting back on the toilet seat makes it easier to adjust the wand position and to reduce splashing.

"Water pressure adjustment"

You can select from 5 levels of water pressure.

- The setting changes by one level whenever you swipe to the left or right.

[-] Softer

[+] Stronger

- After you swipe to change the "Water pressure adjustment" setting, the set position will light for 10 seconds.
- A light will also flash for about 10 seconds to indicate the current setting when any of the cleansing buttons (rear cleansing, rear soft cleansing, front cleansing) are pressed.

"Wand position adjustment"

You can select from 5 levels of wand position between the front and the rear.

- The setting changes by one level whenever you swipe to the left or right.

[▲] Moves to the front

[▼] Moves to the rear

- After you swipe to change the "Wand position adjustment" setting, the set position will light for 10 seconds.
- A light will also flash for about 10 seconds to indicate the current setting when any of the cleansing buttons (rear cleansing, rear soft cleansing, front cleansing) are pressed.

"Personal setting"

You can store your preferred "Water pressure", "Wand position" and "Warm water temperature" settings.

- To store a settings → Page 60
- To use

(Swipe left)

(Swipe right)

Select or and press the button for the cleansing you want to use.

- The "Wand position" and "Water pressure" lamps will light up for about 10 seconds in their set positions, and the "Water temperature" display switches.

*1 Except TCF801CG

*2 Remote control transmitter (Front side, Top side)

Basic Operations

About the Menu Screen

This section is an overview of the settings that can be configured with the remote control.

- See the corresponding pages for the detailed descriptions.

Remote control back side

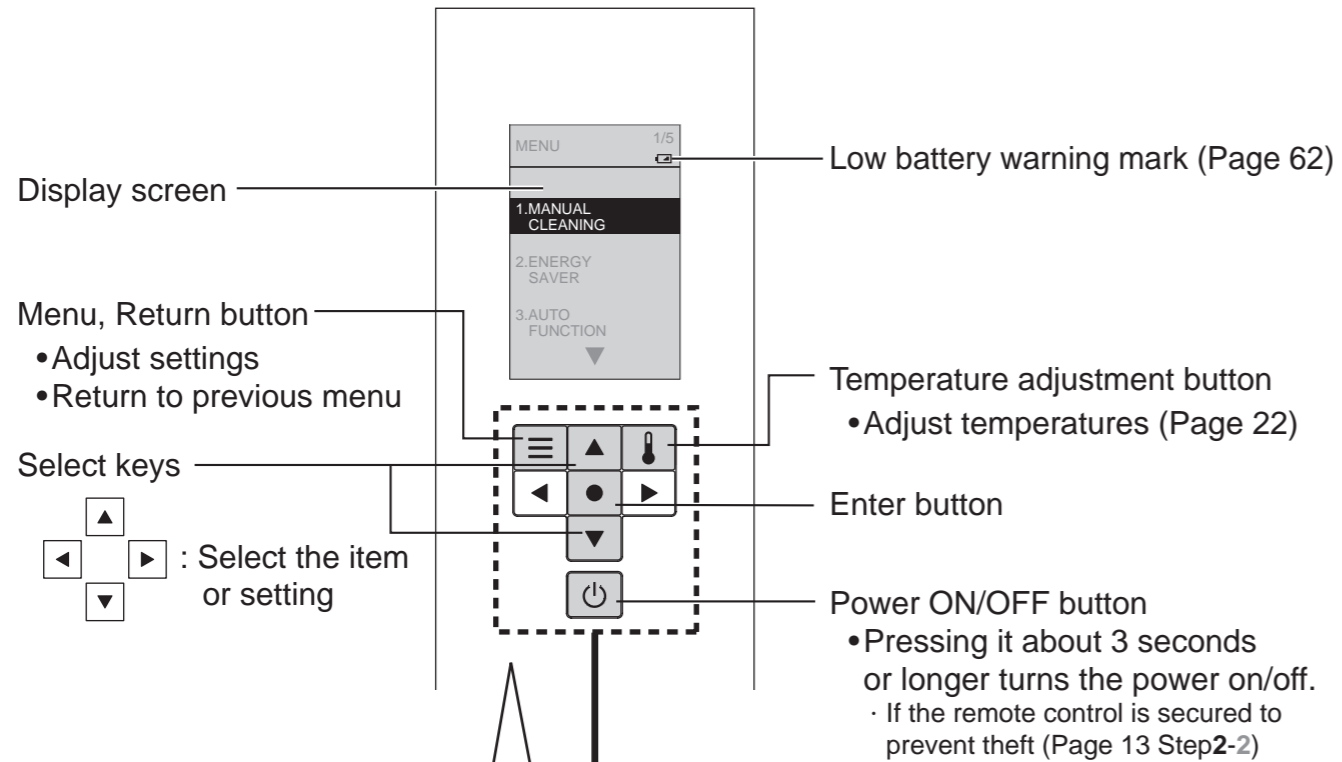

1 Press.

- The display screen changes.

2 Set the item from the display screen.

You can move the ▲ ▼ buttons (Up/Down)

to select the item or setting.

- The letters of the selected item will be highlighted.

When [MANUAL CLEANING] is not chosen

When [MANUAL CLEANING] is chosen



When you press the ● button, the item is entered.

Setting lock

You can lock the settings so that you do not mistakenly operate the rear buttons while using the remote control.

How to Set (Page 58)

Display screen during setting lock

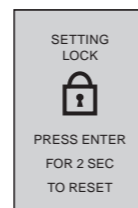

You can set as desired

If you want to return to the previous item, press ≡ the button.

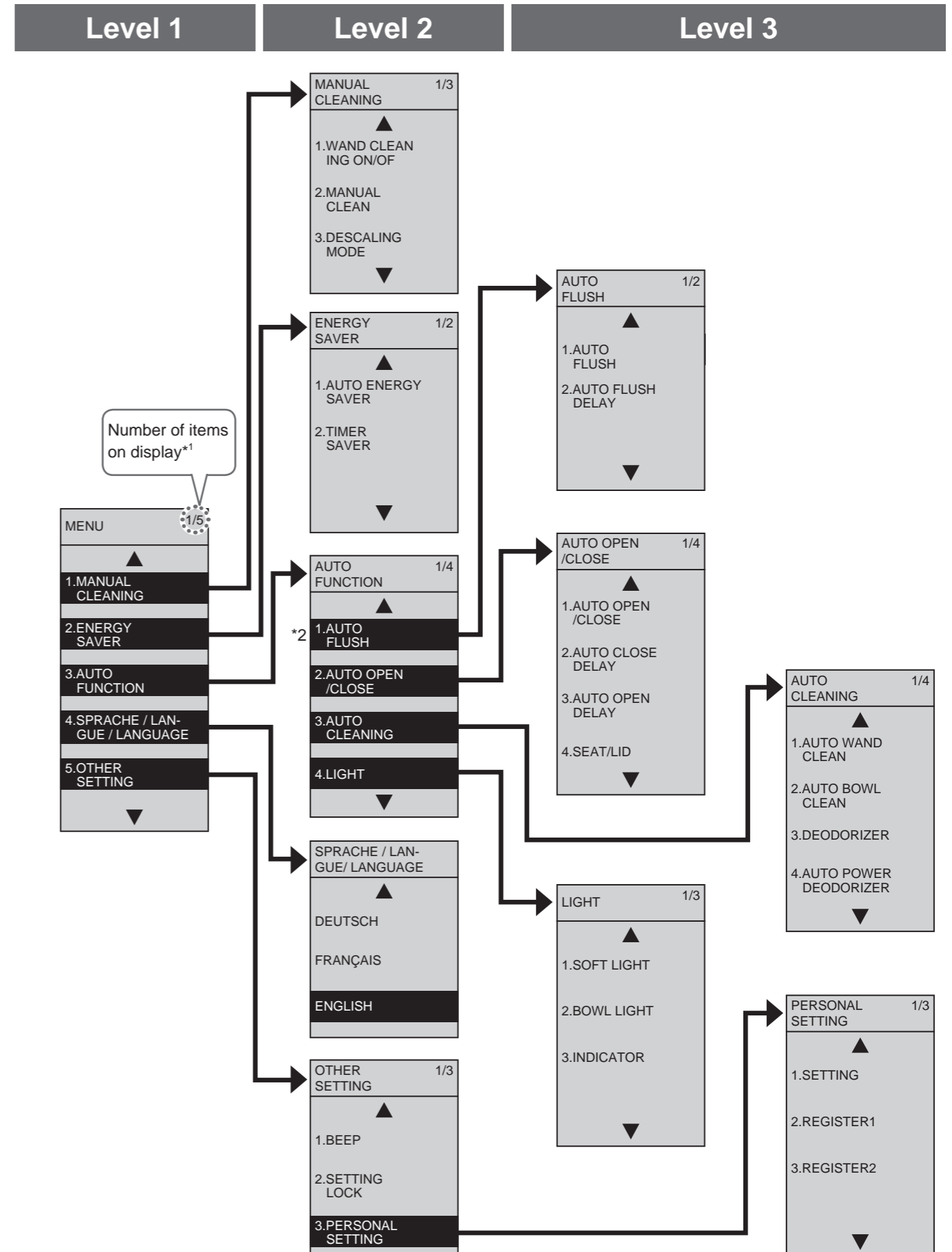

*1 The setting items and numbers vary according to the model.

*2 Except TCF801CG

Automatic Functions Cleaning Features

"ewater+^{*1}" is used automatically to clean the wand and bowl unit.

- Operation under the initial settings is described below.

As you approach

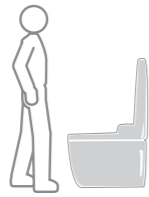

As you sit^{*2}



As you stand up^{*2}



Lights to show that the "CLEAN" functions are operating.

■ **Bowl light**
Lights to show that auto bowl CLEAN and auto wand CLEAN are operating.

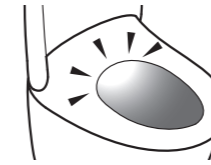

■ **CLEAN indicator**
Lights to show that the "clean" functions are operating.

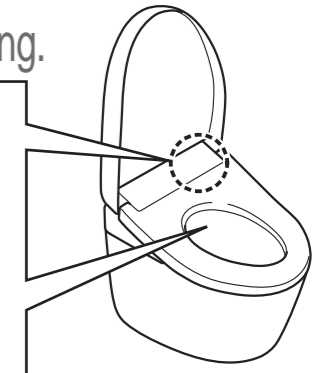

■ Note

■ Changing settings

"ewater+" can also be used by pressing the remote control button

For wand

Press "Wand CLEAN" button

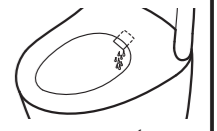

(After wand cleaning, water comes out from around the wand.)

- To clean the wand with it extended. → "Wand cleaning" (Page 30)

For bowl unit (Manual CLEAN)

1 Press.

2 Select [MANUAL CLEANING].

→ Press.

3 Select [MANUAL CLEAN].

→ Press.

("ewater+" mist is sprayed on the bowl unit)

Note

- It cannot be used when the wand is out or when you are sitting on the toilet seat.

***1 What is meant by "ewater+" ?**

This water containing hypochlorous acid generated from chloride ions in tap water, is widely used for cleaning and disinfecting items such as food, utensils and baby bottles.

- Well water may not deliver the required effect. (Because the level of chloride ions is low.)
- "ewater+" helps to minimize dirty surfaces, but does not make cleaning unnecessary.
- The effect and duration vary depending on the usage environment and conditions.

***2** Water comes out from around the wand.

<p>Removing odours inside the bowl unit</p> <p>Deodorizer</p>	<p>Starts the deodorizer</p>	<p>Starts the auto power deodorizer (After about 10 seconds) → It stops after about 60 seconds</p>	<p>• Deodorizing filter needs regular maintenance. (Page 31)</p>	<p>• "Deodorizer" ON/OFF • "Auto power deodorizer" ON/OFF (Page 52 for all)</p>
<p>Cleans the wand with "ewater+^{*1}"</p> <p>Auto wand CLEAN</p>		<p>Cleans the wand automatically (After about 25 seconds) Only when the cleansing functions are used. → The wand extends and "ewater+^{*1}" comes out from the base of the wand</p>	<p>• When the cleansing functions (Rear and Front cleansing etc.) have not been used in 8 hours, the wand is cleaned automatically. (Water comes out from around the wand.)</p>	<p>• "Auto wand CLEAN" ON/OFF (Page 50)</p>
<p>Cleans the bowl unit with "ewater+^{*1}"</p> <p>Auto bowl CLEAN</p>	<p>Pre-mist → A mist is sprayed inside the bowl unit to make it more difficult for dirt to adhere</p>	<p>After-mist (After auto wand CLEAN) If the cleansing functions are not used, after-mist starts after about 25 seconds. → "ewater+^{*1}" mist is sprayed on the bowl unit</p>	<p>• The pre-mist and after-mist are not sprayed if the toilet seat is open. • The pre-mist does not work for about 90 seconds after the after-mist has finished. • When the cleansing feature (Rear and Front cleansing etc.) is not used for about 8 hours, mist is sprayed on the bowl unit automatically.</p>	<p>• "Auto bowl CLEAN" ON/OFF (Page 50)</p>
<p>Bowl light</p>	<p>Lights up during pre-mist</p>	<p>Lights up during auto wand CLEAN and after-mist</p>		<p>• "Bowl light" ON/OFF (Page 54)</p>
<p>CLEAN indicator</p>	<p>(Lights up)</p>	<p>(Lights up in a cycle)</p>	<p>• Lights up continuously or in a cycle when "Auto wand CLEAN", "Auto bowl CLEAN" or "Auto power deodorizer" is operating. (Lights only when the toilet seat is not in-use)</p>	<p>• "CLEAN indicator" ON/OFF (Page 54)</p>

Automatic Functions

Convenience Features

Various automatic functions are available.
 • Operation under the initial settings is described below.

As you approach

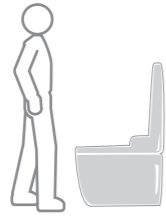

As you sit



As you stand up



As you move away

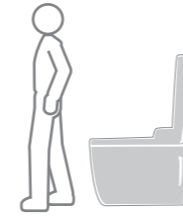

Note

Changing settings

Flush automatically

Auto flushing*¹

When using the toilet seat

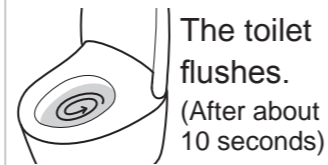

When standing and using

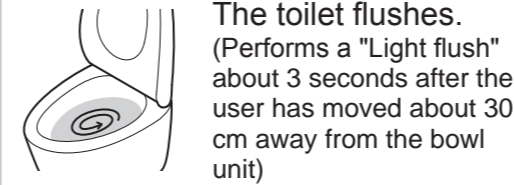

- Auto flush is not available in the following cases.
 - About 60 seconds after the toilet is flushed. (After 60 seconds have passed, flush using the remote control.)
 - When the time spent sitting on the toilet seat or standing in front of the bowl unit is less than about 6 seconds. (Flush with the remote control.)
- The flushing varies depending on how long you sit on the toilet seat.
 - About 6 to 30 seconds: "Light flush"
 - About 30 seconds or more: "Full flush"

- "Auto flushing" ON/OFF
- "Auto flush delay" (5 seconds, 10 seconds or 15 seconds) (Page 44 for all)

Opening the toilet lid automatically

Auto open / close

When using the toilet seat



When standing and using



- When the toilet lid is closed with the remote control or by hand, it cannot open automatically for about 15 seconds. (Open and close manually.)
- When you do not sit on the toilet seat, or when you sit on it or stand in front of the bowl unit briefly, it takes about 5 minutes before the lid close automatically.

- "Auto open/close" ON/OFF
- "Auto close delay" (25 seconds or 90 seconds) (Page 46 for all)
- "Auto open delay" (15 seconds, 30 seconds or 90 seconds)
- "Seat/lid" (Lid/Seat · Lid) (Page 48 for all)

Lighting up the inside of the bathroom with a soft light

Soft light

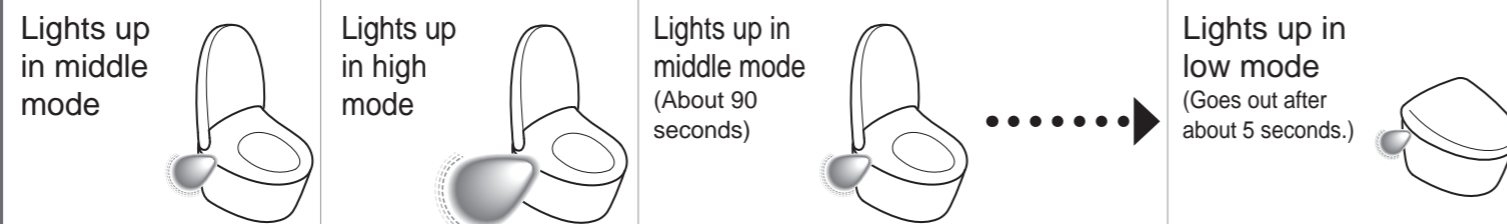

- "Soft light" ON/OFF (Page 54)

*1 Except TCF801CG

Temperature Adjustment Warm Water, Toilet Seat, Drying

Five different temperature levels from high to low and "OFF" can be set.

- 1** Remove the remote control from the hanger.
 - If the remote control is secured to prevent theft (Page 12)
- 2** Press.
- 3** Select the item you want to set.

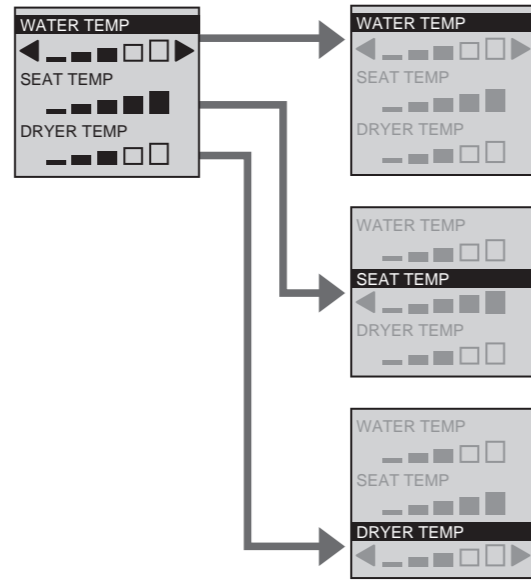

- 4** Select the temperature level.

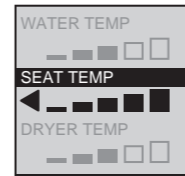

<Settings complete>

- 5** Mount the remote control in the hanger.
 - If the remote control is secured to prevent theft (Page 12)

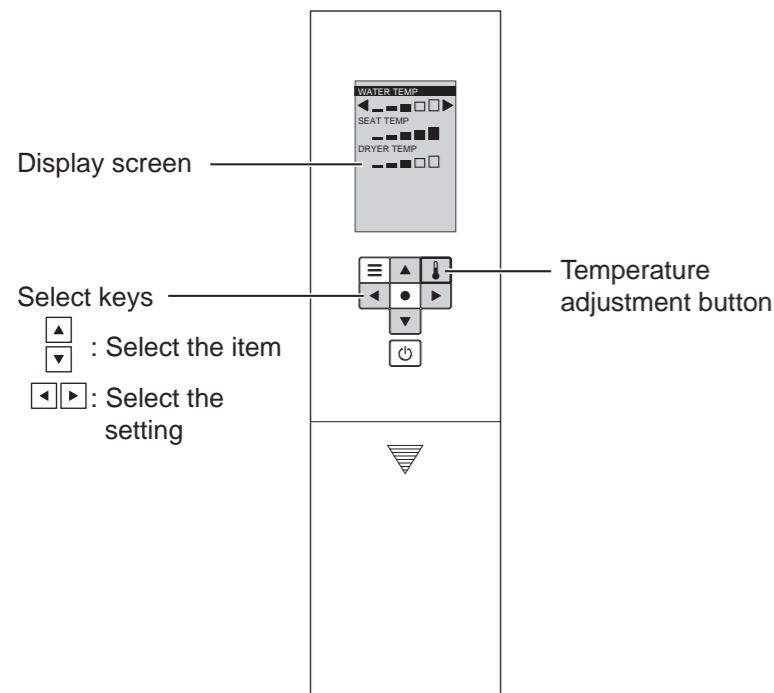

Warm water temperature	<p>Press until [OFF] appears.</p>
Toilet seat temperature	<p>Press until [OFF] appears.</p> <ul style="list-style-type: none"> • When "OFF" is set, the "Seat" LED on the main display will go off.
Drying air temperature	<ul style="list-style-type: none"> • The "Drying" cannot be turned "OFF".

*1 To prevent condensation, the water temperature does not drop below 20 °C even when set to "OFF".

● If adjusting the temperature does not warm up the toilet seat → Is the energy saver set to "ON"? (Page 24)

CAUTION

● During setting, the display goes out when no button is pressed within about 60 seconds. If you fail to complete the setting, redo from the step 2.

Energy Saver Features Type

"Auto energy saver", "Auto energy saver+" or "Timer energy saver" can be selected. To save energy, the temperature of the toilet seat becomes low (or "OFF").

● "Auto energy saver" takes about 10 days to detect time periods in which the toilet seat is never or infrequently used.

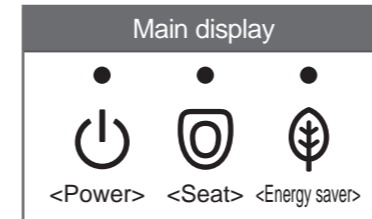

Type	Situation	Energy saver is on	When energy saver is in operation		AM		PM				
			Main display	Toilet seat heater	0	4	6	8	5	9	0
Auto energy saver	You want the product to save energy automatically. The product detects time periods with infrequent use and lowers the toilet seat temperature automatically.				Example: Used infrequently from 9 pm to 6 am Set temperature ^{*1}						
Auto energy saver+	You want to save more energy. In addition to the "Auto energy saver" feature, it automatically turns off the toilet seat heater during time periods when the toilet is never used.				Example: Not used from 0 am to 4 am Set temperature ^{*1}						
Timer energy saver	You want to save energy only for the preset duration of time. (6 hours, 9 hours) Once the time is set, the toilet seat heater turn off automatically during the set time period every day.				Example: Set from 8 am to 5 pm Set temperature ^{*1}						
Timer energy saver and Auto energy saver / Auto energy saver+	You want to save a lot of energy with "Auto energy saver" and "Timer energy saver". When both "Timer energy saver" and "Auto energy saver / Auto energy saver+" are set, "Auto energy saver / Auto energy saver+" operates when "Timer energy saver" is not operating.				Example: When "Timer energy saver" and "Auto energy saver+" are used together Set temperature ^{*1}						

● Even if the energy saver feature is on (i.e., the toilet seat heater is set to "Low" or "OFF"), the toilet seat is heated to the set temperature in about 15 minutes. (The LED indication on the main display returns to the state for when the energy saver is on.)

*1 The toilet seat temperature set on page 22.

*2 The time period when the toilet seat heater is set to a "Low".

*3 The time period when the toilet seat heater is set to a "OFF"

Operation



Energy Saver Features How to Set

Set the "Timer energy saver" at the time you want to start it.

1 Press.

2 Select [ENERGY SAVER].

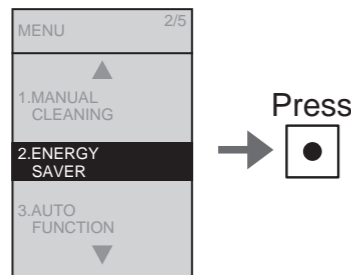

Press

Display screen

Menu, Return button

Enter button

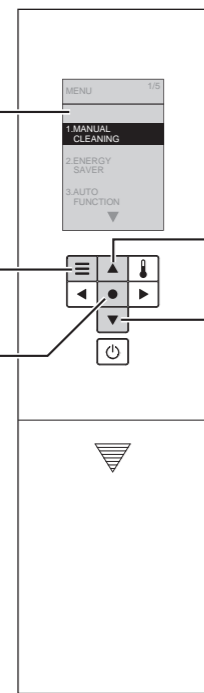

Select keys

: Select the item or setting

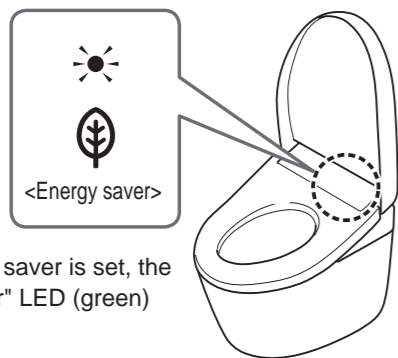

When energy saver is set, the "Energy saver" LED (green) lights up.

CAUTION

● During setting, the display goes out when no button is pressed within about 60 seconds. If you fail to complete the setting, redo from the step 1.

Auto energy saver

3 Select [AUTO ENERGY SAVER].

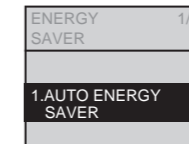

Press

4 Select [AUTO ENERGY SAVER].

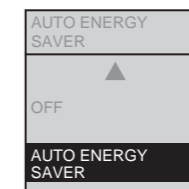

Press

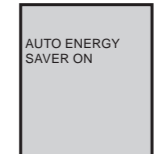

(To return →)

Auto energy saver+

3 Select [AUTO ENERGY SAVER].

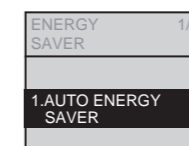

Press

4 Select [AUTO ENERGY SAVER+].

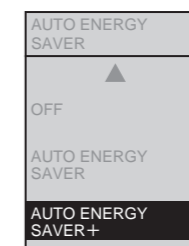

Press

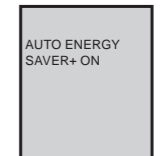

(To return →)

Timer energy saver

3 Select [TIMER SAVER].

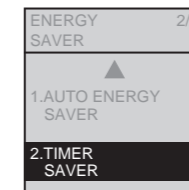

Press

4 Select [6H] or [9H].

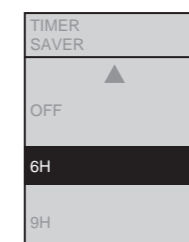

Press



(To return →)

■ To change the timer energy saver time → Set the timer energy saver again at the time you want to start it.

Turning off energy saver

Select [OFF] in step 4 in each procedure above and then press .

Maintenance

⚠ WARNING

! Always flip the power switch to OFF before maintenance or inspection.
(Failure to do so may cause electric shock or malfunction, resulting in a breakdown.)

For safety, flip the power switch to OFF before maintenance.*1*2

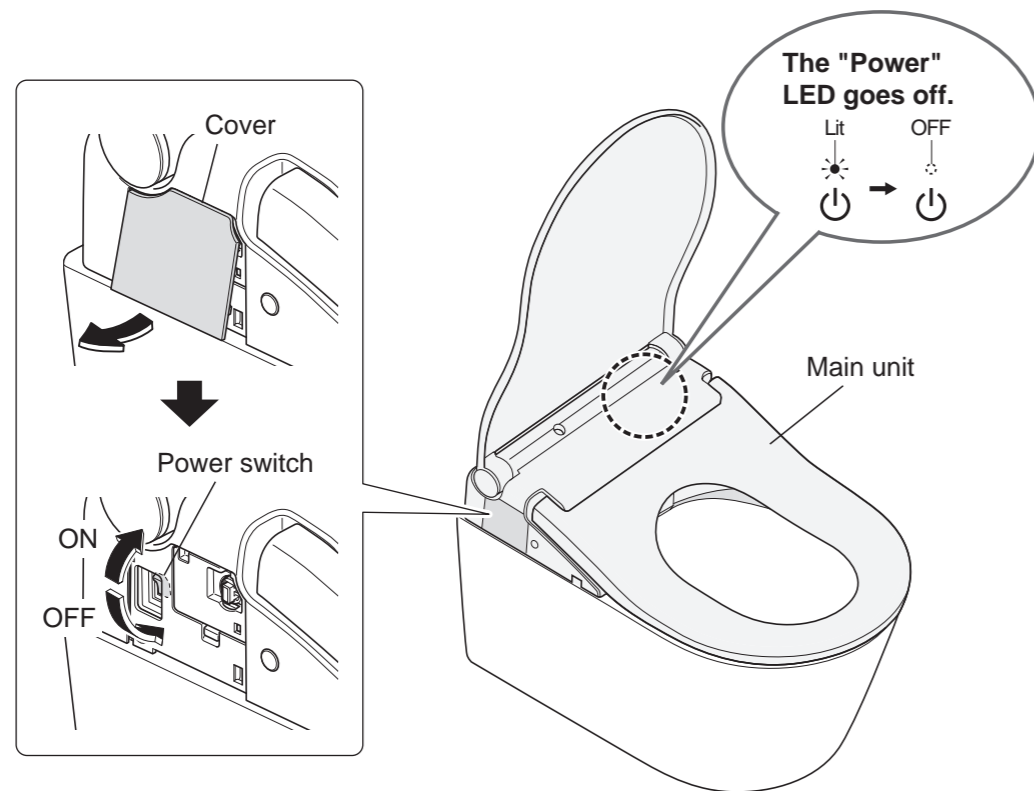

Do not use a dry cloth or toilet paper on plastic parts.
(May cause damage.)

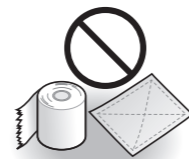

*1 Except when using "Wand cleaning", "Descaling mode" or "Spray nozzle".

*2 After flip the power switch to "ON", the toilet lid does not open automatically for about 10 to 60 seconds. (Because it is preparing for operation.) Open and close by hand.

Main Unit

Main Unit (Approximately daily)

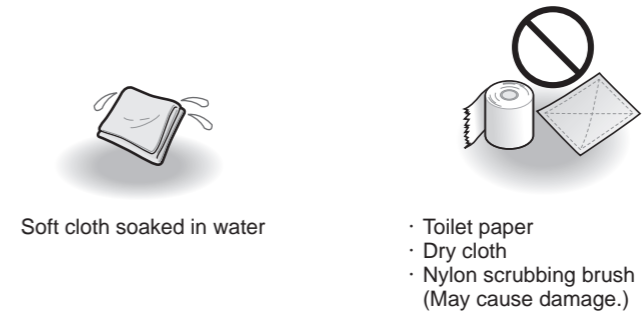

1 Remove the cover on the left side of the main unit, and flip the power switch to "OFF". (Page 28)

2 Wipe with a soft cloth that has been soaked in water and wrung out thoroughly.

■ For heavy dirt

- Wipe with a soft cloth soaked in diluted, neutral kitchen detergent, and then wipe with a soft cloth soaked in water.

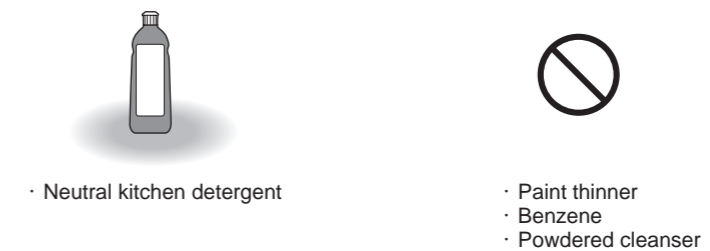

3 Flip the power switch to ON. (Page 28)

- The "Power" LED lights up.

4 Reinstall the cover.

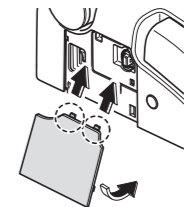

Attention!

- This product is an electric appliance. Be careful not to let water seep inside or leave detergent in the gap between the main unit and bowl unit. (May damage plastic parts or cause a malfunction.)
- When using a toilet cleaner to clean the toilet, rinse it off within 3 minutes and leave the toilet seat and toilet lid open.
 - Wipe off any cleaner that remains on the bowl unit. (If vapor from a toilet cleaner enters the main unit, it may cause a malfunction.)
- Do not push or pull the covers around the wand with undue force. (May cause damage or malfunction.)
- Wipe the back surface of the toilet seat and the toilet seat cushions with a soft cloth tightly wrung out with water. (Otherwise adhesion of dirt may result in discoloration.)
- Please wipe any water droplets so that none remain on the toilet seat. (Failure to do so may cause malfunction of the seat sensor.)

Wand (Approximately once a month) <If you notice dirt (Wand cleaning)>



Soft cloth soaked in water

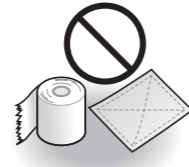

Toilet paper, etc.
(May cause damage.)

1 Extend the wand.

To operate from the back of remote control

- (1) Press.
- (2) Select [MANUAL CLEANING].
- Press.
- (3) Select [WAND CLEANING ON/OFF].
- Press.

To operate from the front of remote control

- Recommended if the remote control is secured to prevent theft, etc.
- (1) Press "Stopping" button about 10 seconds or longer.
 - The main unit makes a beep sound.
 - (2) Press "Front cleansing" button about 3 seconds or longer.

2 Wipe with a soft cloth that has been soaked in water and wrung out thoroughly.

- Do not pull, push or press the wand with excessive force.
(May cause damage or malfunction.)

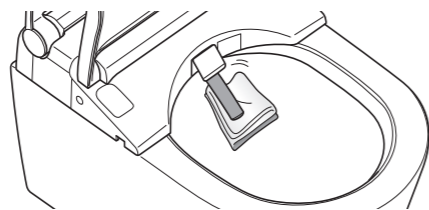

3 Press "Stopping" button on the front side of the remote control.

- The wand retracts.
- Water comes out from around the wand.

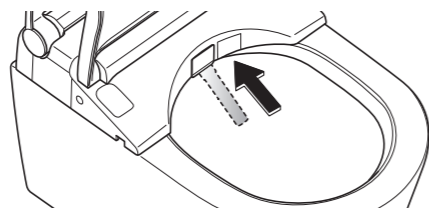

Deodorizing Filter (Approximately once a month)

1 Remove the cover on the left side of the main unit, and flip the power switch to "OFF". (Page 28)

2 Remove the deodorizing filter.

- Hold the knob and pull outward.
- Do not pull with undue force. (May cause damage or malfunction.)

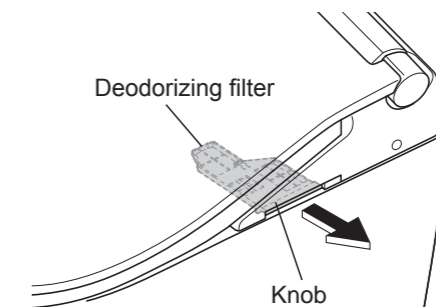

3 Clean with a tool such as a toothbrush.

- When washing with water, dry off all water before mounting.

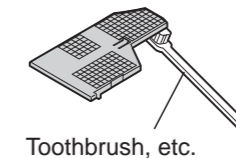

4 Mount the deodorizing filter.

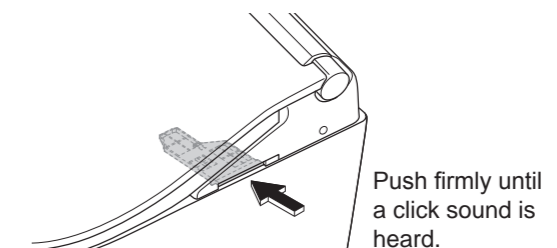

5 Flip the power switch to ON. (Page 28)

- The "Power" LED lights up.

6 Reinstall the cover. (Page 29)

Gap between the Main Unit and Bowl Unit (Approximately once a month)

You can remove the main unit to clean the top of the bowl unit and the bottom of the main unit.



Soft cloth soaked in water Toilet paper, etc. (May cause damage.)

1 Remove the cover on the left side of the main unit, and flip the power switch to "OFF". (Page 28)

If the power switch is not turned "OFF", the unit may malfunction or cause a failure or electric shock.

2 Remove the main unit (a string is attached to the bottom of the main unit).

- Pull the main unit toward you while pressing the "Main unit removal button".

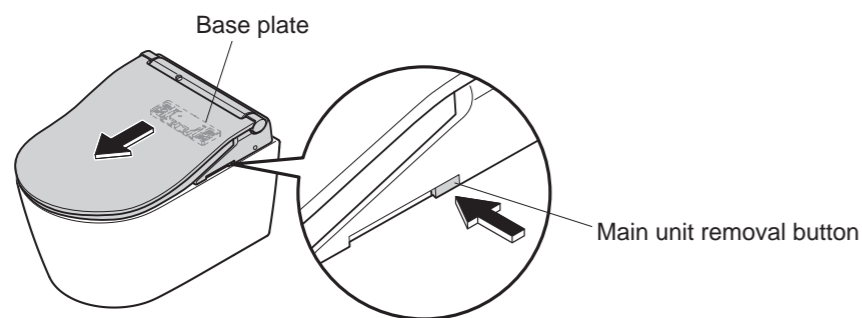

Attention • Do not pull the unit with undue force (The main unit is connected to the base plate using a string.)

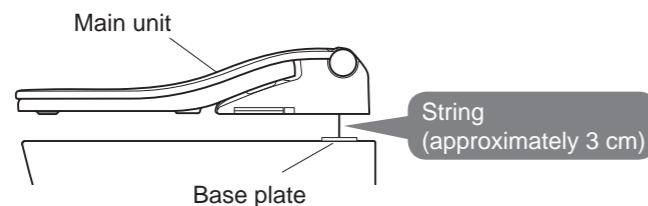

3 Clean the top of the bowl unit and the bottom of the main unit.

- Wipe with a soft cloth soaked in a diluted, neutral kitchen detergent. Then, wipe it with a soft cloth soaked in water so that no detergent remains.

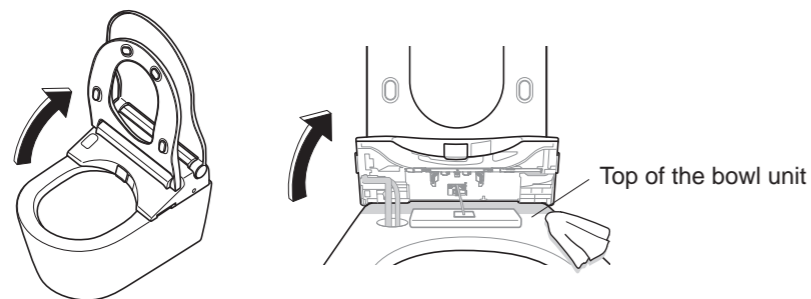

Gap between the Main Unit and Bowl Unit (Approximately once a month) (Continued)

4 Mount the main unit.

- (1) Lift the main unit, then lower it straight down while threading the power cord and water supply hose into the recess on the bowl unit.

Attention!

- Be careful not to pinch the power cord.
- Do not excessively bend the water supply hose.

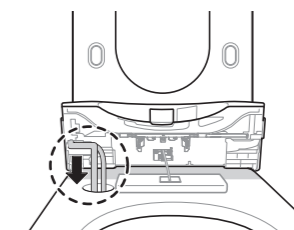

- (2) Align the main unit with the center of the base plate and press it firmly onto the base plate until a click sound is heard.

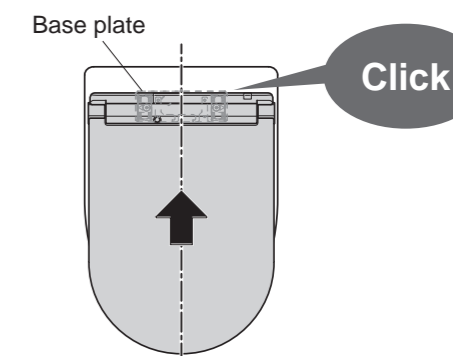

CAUTION

! Push the main unit firmly on to the base plate until a click sound is heard. (Failure to do so could cause the main unit to come loose resulting in injury.)

After mounting, check that the main unit does not detach even when pulled.

5 Flip the power switch to ON. (Page 28)

- The "Power" LED lights up.

6 Reinstall the cover. (Page 29)

Gap between the Main Unit and the Toilet Lid

Gap between the Main Unit and the Toilet Lid (Approximately once a month)

The toilet lid can be removed for thorough cleaning.

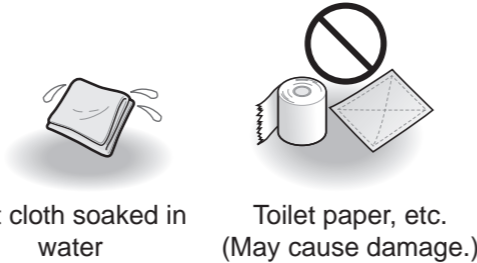

- 1** Remove the cover on the left side of the main unit, and flip the power switch to "OFF". (Page 28)
- 2** Remove the toilet lid. Strongly pull it out, starting with **A** and finishing with **B**.
- 3** Wipe with a soft cloth that has been soaked in water and wrungout thoroughly.
- 4** Reinstall the toilet lid. Insert **C** and then **D** into the pins. * Do not use excessive force.
- 5** Flip the power switch to ON. (Page 28)
 - The "Power" LED lights up.
- 6** Reinstall the cover. (Page 29)
- 7** Open and close the toilet lid to check the reinstallation.

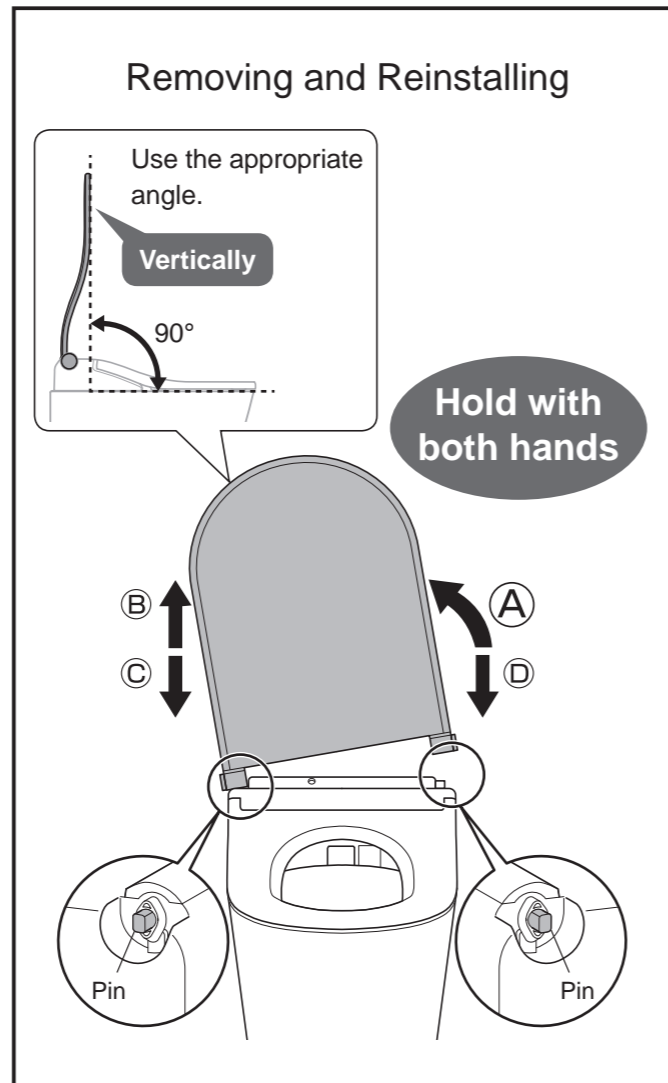

Descaling mode

Descaling mode <If you think the water pressure has weakened>

<When "Power" LED (orange) and "Energy saver" LED (orange) flash>

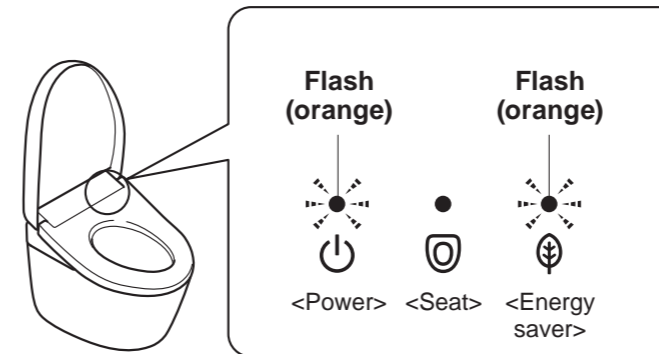

**Please perform
Descaling mode**

Do not perform descaling mode when the main unit is removed. It may cause a failure in the unit.

Items to prepare



Beaker (included item)



Funnel (included item)

Descaling agent (TOTO specified)

Attention!

- Please use one of the following descaling agents at specified concentration. (Failure to do so may cause damage)
- If you wish to use other agents, please contact us at the phone number on the back of this manual.

Product name	Manufacturer
Sidol® Universal-Entkalker (liquid)	Henkel AG & Co. KGaA
Bref POWER® Universal-Entkalker (liquid)	
Oust® ALL PURPOSE DESCALER (liquid)	

Product name	Manufacturer
swiril® Anti Calc Bio Power Concentrate	Melitta Group
swiril® Anti Calc Bio flüssig	

How to dilute

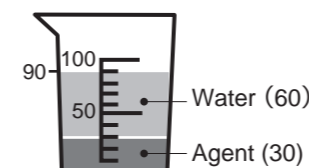

Pour and mix thoroughly

■ If the beaker is missing

Please use a clean cup and dilute 30ml of agent with 60ml of water.

How to dilute

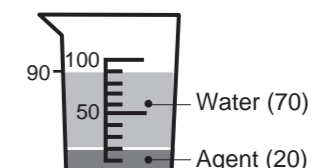

Pour and mix thoroughly

■ If the beaker is missing

Please use a clean cup and dilute 20ml of agent with 70ml of water.

[SIDOL], [Bref POWER] and [OUST] are registered trademarks of [Henkel AG & Co. KGaA]. [swiril] is a trademark of company of the [Melitta Group].

Descaling mode

<If you think the water pressure has weakened>

<When "Power" LED (orange) and "Energy saver" LED (orange) flash> (Continued)

Note

- Cleansing modes (Rear, rear soft and soft) cannot be used from step 2 until 60 minutes after step 9 of descaling is performed. (Toilet can be flushed)
- Lid will not open automatically from step 2 until 10 minutes after step 9 of descaling is performed. Please open manually.
- If the work is delayed for more than 30 minutes between steps 2 and 9, descaling agent will be drained to the toilet with a long beep sound to alert.
- If you want to stop the work between steps 1 and 9, flip the power switch to "OFF", and then flip it to ON. (page 28)
(Descaling agent will be drained to the toilet with a long beep sound to alert.)
Cleansing modes (rear, rear soft and front) cannot be used while the long beep sound is alerting.)

1 SET DESCALING MODE.

- Operate with the buttons on the back side of the remote control.

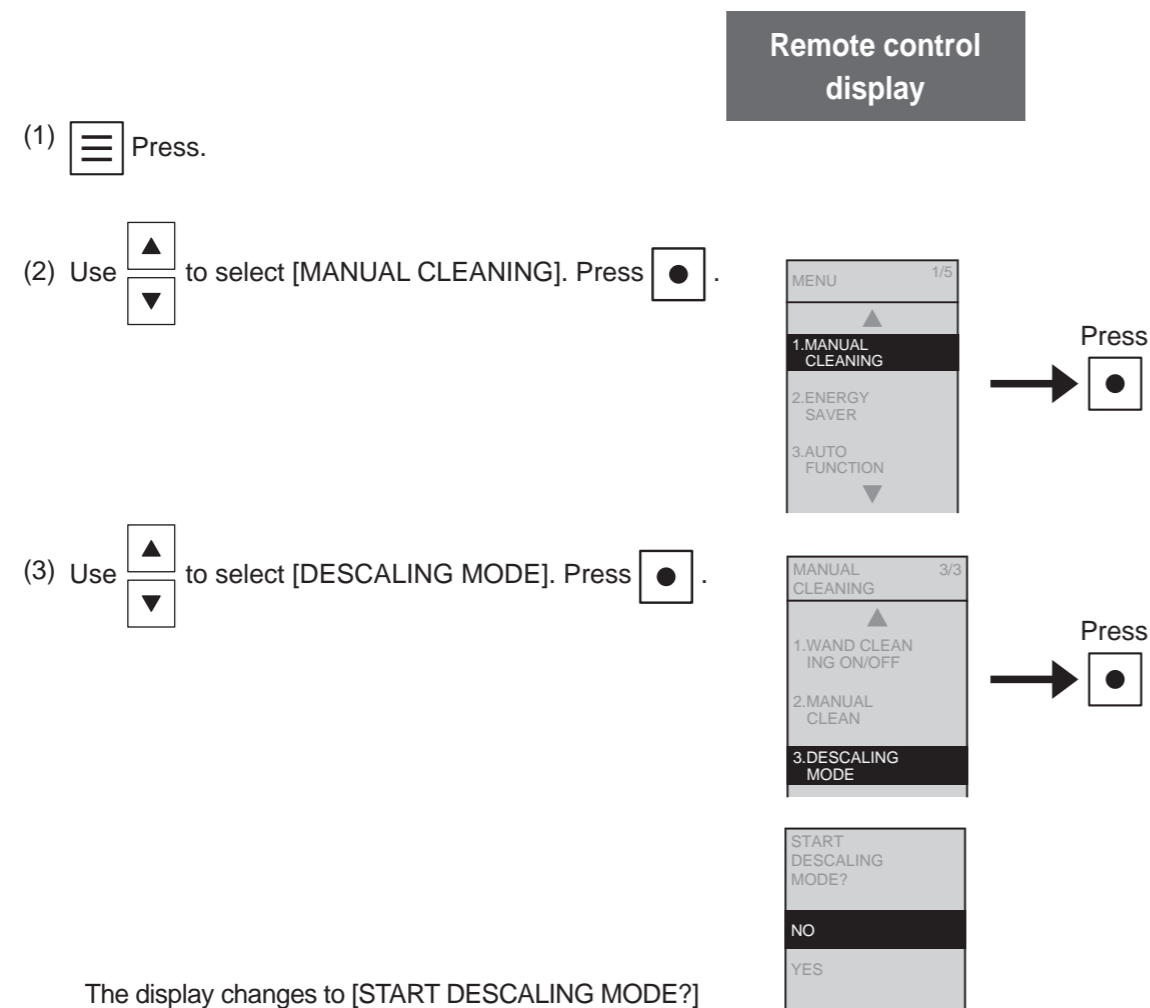

2 Drain water passage.

- (1) Use to select [YES]. Press .

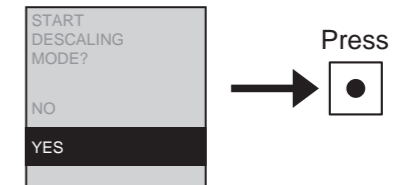

Water passage is drained.
(for about 30 seconds)

- You will hear short beep sound while the work is in progress, and a long beep sound upon completion.
- Water comes out from around the wand.
- "Power" LED (green) and "Energy saver" LED (green) will flash.
(The LEDs will continue to flash until the completion of entire descaling work.)

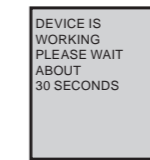

- (2) When the beep stops. Press .



Attention!

- The display shows [FILLING IN THE DESCALING AGENT (1/2)], but please DO NOT press until you have completed filling in descaling agent. (Descaling will not work correctly)

3 Dilute agent with water. (1st time)

(see process **How to dilute** on page 35)

4 Close the lid and remove cover and cap on the top face of product.

Attention!

- Please retain cover and cap.

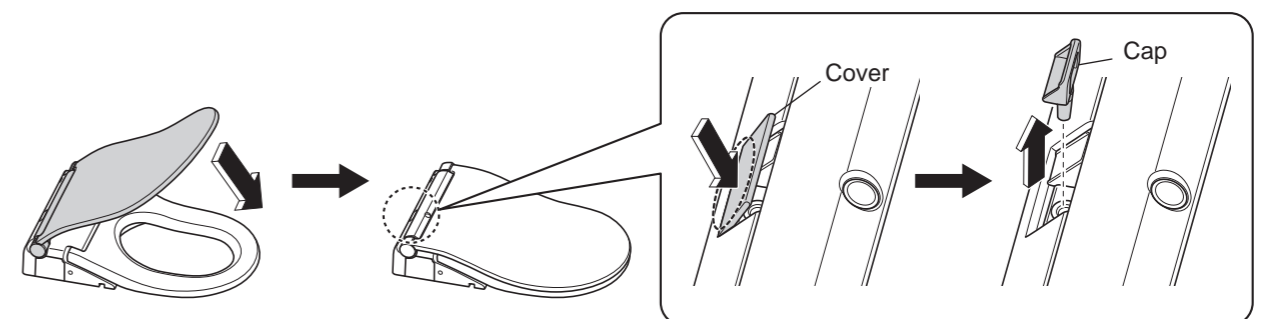

Descaling mode

<If you think the water pressure has weakened>

<When "Power" LED (orange) and "Energy saver" LED (orange) flash> (Continued)

5 Insert funnel and pour diluted agent. (1st time)

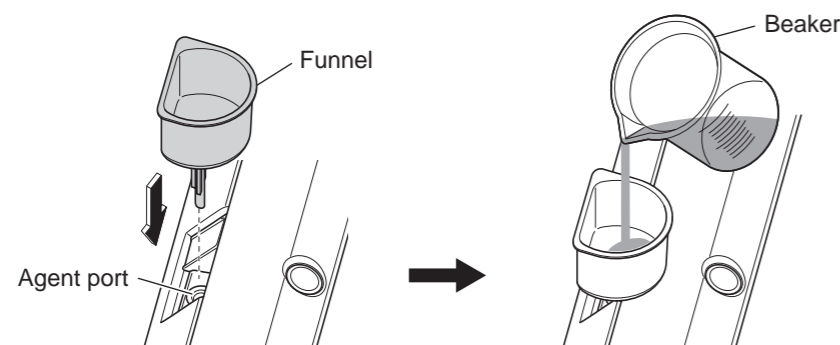

Attention!

- Please wait until funnel is empty. (Descaling will not work correctly)
- If any cleaning agent is spilled on the product, please wipe it off with a soft cloth that has been soaked in water and wrung out thoroughly. (Failure to do so may cause discoloration)

6 Perform descaling. (1st time)

(1) Press .



Descaling will be performed. (for about 30 seconds)

- You will hear short beep sound while the work is in progress, and a long beep sound upon completion.
- Water comes out from around the wand and mist nozzle.

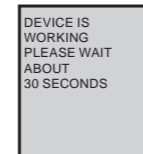

(2) When the beep stops

Press .



Attention!

- The display shows [FILLING IN THE DESCALING AGENT (2/2)], but please DO NOT press until you have completed filling in descaling agent. (Descaling will not work correctly)

7 Dilute agent with water. (2nd time)

(see process [How to dilute](#) on page 35)

8 Pour diluted agent. (2nd time) (see process [5](#) on page 38)

Attention!

- Please wait until funnel is empty. (Descaling will not work correctly)

9 Remove the funnel and put cap and cover back on.

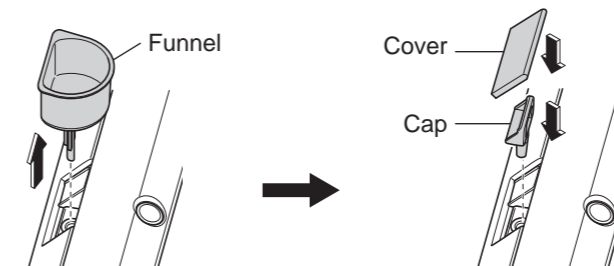

Attention!

- If any cleaning agent is spilled on the product, please wipe it off with a soft cloth that has been soaked in water and wrung out thoroughly. (Failure to do so may cause discoloration)

10 Perform descaling. (2nd time)

Press .

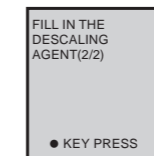

Descaling will be performed. (for about 60 minutes)

- Water comes out from around the wand and mist nozzle at about 20 minutes intervals.

After about 60 minutes, descaling agent will be drained to the toilet.

After draining, you will hear a long beep sound, and the LEDs on product main body stop flashing.

<Descaling complete>

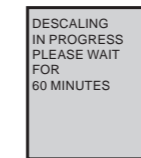

Returns to default display in about 30 seconds.

Attention!

- If the spray is still weak after performing **Descaling mode**, please clean **Water filter drain valve**.
- If the water pressure is still weak even after performing **Descaling mode** and **Water filter drain valve** cleaning, please clean **Spray Nozzle**.
- If the symptom does not improve after performing **Descaling mode**, cleaning **Water filter drain valve** and **Spray Nozzle** or if the "Power" (orange) and "Energy saver" (orange) LEDs start to flash, please perform **Descaling mode** again.

Water Filter Drain Valve

Water Filter Drain Valve (Approximately once every 6 months)

<If the water pressure is still weak even after performing descaling>

- 1 Close the shutoff valve. (Page 67)
 - The water supply stops.

CAUTION

Do not remove the water filter drain valve while the shutoff valve is open.
(Otherwise, water may leak out)

- 2  Press "Wand CLEAN" button.

(Release the pressure from the water supply pipe.)
• Water comes out from around the wand.

- 3 Remove the cover on the left side of the main unit, and flip the power switch to "OFF". (Page 28)

- 4 Remove the water filter drain valve.
 - Loosen the water filter drain valve with a flat-head screwdriver and then pull it.

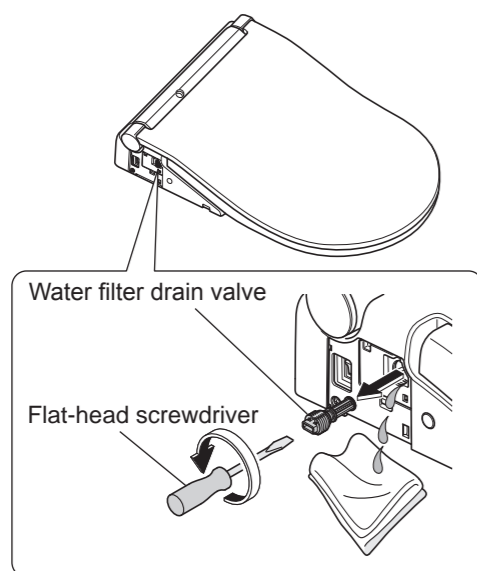

- 5 Clean the filter with a tool such as a toothbrush.
 - Also, remove any dust from inside the hole of the water filter drain valve.

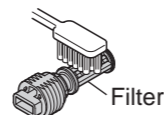

- 6 Reinstall the water filter drain valve.
 - Insert the water filter drain valve and use a flat-head screwdriver to tighten it securely.

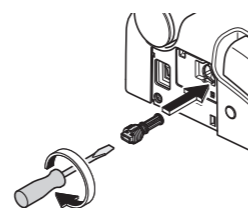

- 7 Flip the power switch to ON. (Page 28)
 - The "Power" LED lights up.

- 8 Reinstall the cover. (Page 29)

- 9 Open the shutoff valve. (Page 13)

Spray Nozzle

Spray Nozzle

<If the water pressure is still weak even after performing descaling and water filter drain valve cleaning>

- 1 Remove the spray nozzle from the wand
 - (1) Extend the wand. (see process 1 on page 30)
 - (2) While holding the wand with a hand, press on both sides of the spray nozzle and slide it.

• Do not pull with undue force. (May cause damage or malfunction.)

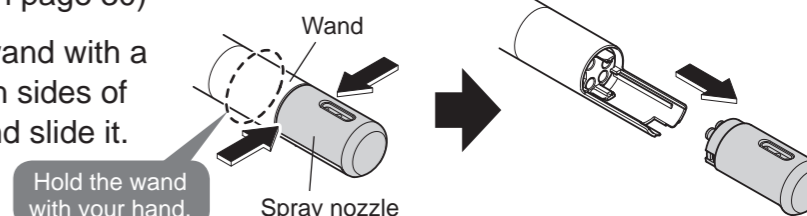

- 2 Install a spray nozzle (for replacement).

Check that the gasket (black) is attached.



- (1) Hold the wand by hand and slide the replacement spray nozzle along the guide and push it in.
 - Install correctly until a click sound is heard.
 - Do not push with undue force. (May cause damage or malfunction.)

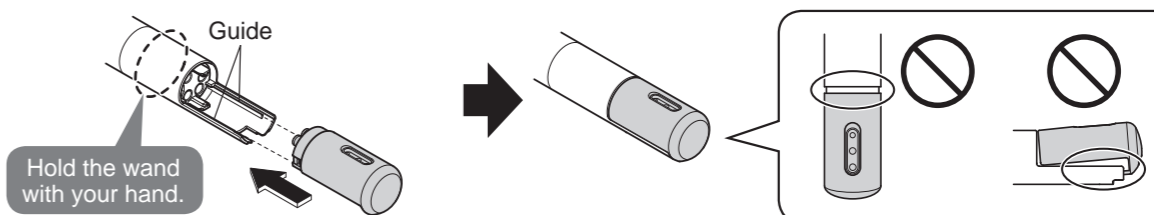

- (2) ■ Press "Stopping" button on the front side of the remote control.
 - The wand retracts.
 - Water comes out from around the wand.

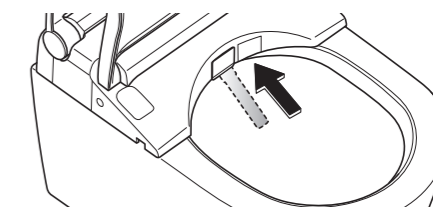

Attention!

• Keep the spare nozzle in safe place.

Cleaning the blocked Nozzle



Descaling agent specified by TOTO (Page 35)



Other detergents

Clean the removed spray nozzle using the descaling agent specified by TOTO (Page 35).

• Do not disassemble the spray nozzle. (May cause malfunctions.)

Changing Settings

Setting List

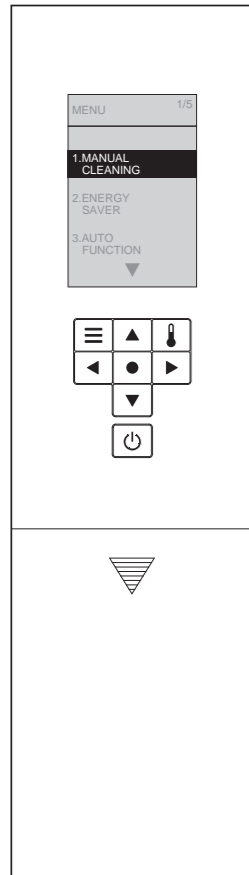

Setting Types			Available Settings • Bold: Initial settings	Applicable Models	How to Set Ref. Page		
Auto functions	Auto flushing	Auto flushing	• Set whether or not to clean the bowl unit automatically	ON / OFF	TCF802C2G	Page 44	
		Auto flush delay	• Change the amount of time before the toilet flushes automatically	5seconds / 10seconds / 15seconds			
	Auto open / close	Auto open / close	• Set whether or not to open and close the toilet lid automatically	ON / OFF	All models	Page 46	
		Auto close delay	• Change the amount of time before the lid/seat closes automatically	25seconds / 90seconds			
		Auto open delay	• Change the amount of time after which the lid/seat opens automatically upon closing it with hands	15seconds / 30seconds / 90seconds		Page 48	
		Seat/lid	• Automatically open and close the toilet lid/Automatically open and close the toilet seat and toilet lid	Lid / Seat · Lid			
	Cleaning Features	Auto wand CLEAN	• Set whether or not to clean the wand automatically	ON / OFF	All models	Page 50	
		Auto bowl CLEAN	• Set whether or not to spray mist in the bowl unit automatically	ON / OFF		Page 52	
		Deodorizer	• Set whether or not to deodorize automatically after sitting on the toilet seat	ON / OFF			
		Auto power deodorizer	• Set whether or not to power deodorize automatically after standing up	ON / OFF			
	Light	Soft light	• Set whether or not to use the soft light	ON / OFF	All models	Page 54	
		Bowl light	• Set whether or not to use the light inside the bowl unit	ON / OFF			
		CLEAN indicator	• Set whether or not to light up the CLEAN indicator	ON / OFF			
	Language settings			• Select the language displayed on the back of remote control	DEUTSCH/ FRANÇAIS/ ENGLISH	All models	Page 56
	Other settings	Beep sound		• Set whether or not to make a beep sound	ON / OFF		Page 58
Setting lock		• Set whether or not to use the setting lock	ON / OFF				
Personal setting		Setting		• Set whether or not to use the personal setting	ON / OFF	Page 60	
	Register1	Register2	• Set to remember your favorite pressure, wand position and water temperature settings	Register1 / Register2			

CAUTION

● During setting, the display goes out when no button is pressed within about 60 seconds. If you fail to complete the setting, redo from the step 1.

Changing Settings

Auto flushing

1 Press.

2 Select
[AUTO FUNCTION].

3 Select
[AUTO FLUSH].

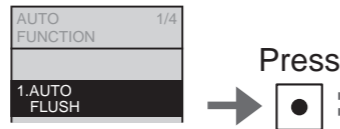
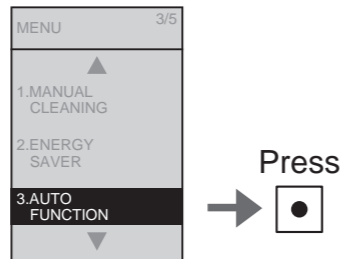

Set whether or not to clean the bowl unit automatically

Auto flushing

4 Select
[AUTO FLUSH].

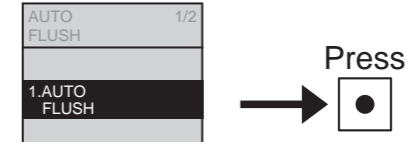

5 Select
[ON] or [OFF].

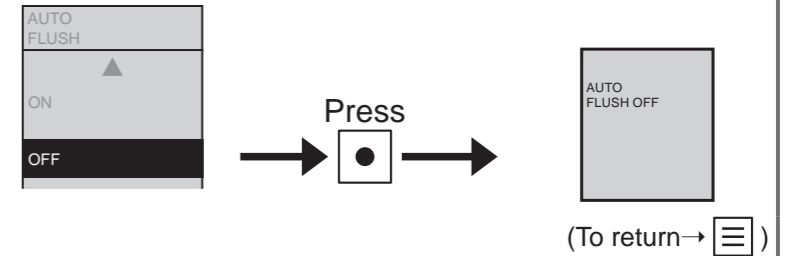

Change the amount of time before the toilet flushes automatically

Auto flush delay

4 Select
[AUTO FLUSH DELAY].

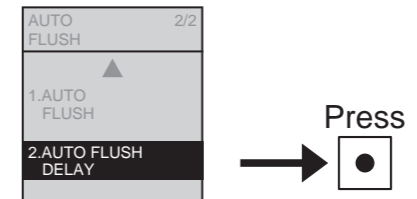

5 Select
[5S], [10S] or [15S].

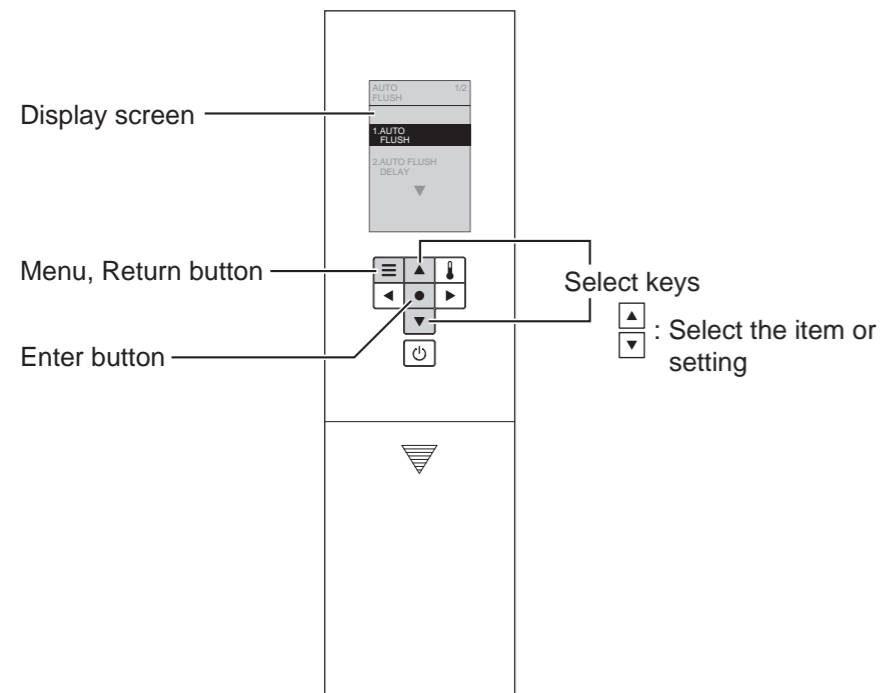
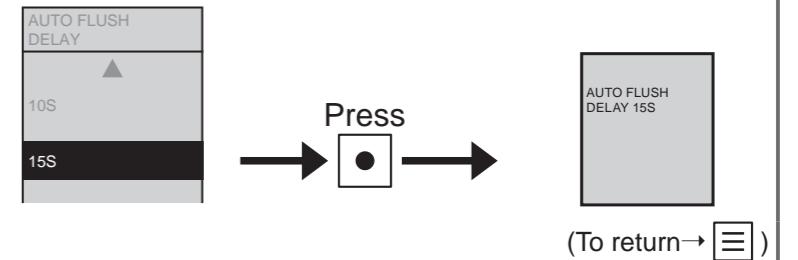

- Items set on this display
1. AUTO FLUSH
"Auto flushing"
 2. AUTO FLUSH DELAY
"Auto flush delay"

Changing Settings

Auto open / close

1 Press.

2 Select
[AUTO FUNCTION].

3 Select
[AUTO OPEN/
CLOSE].

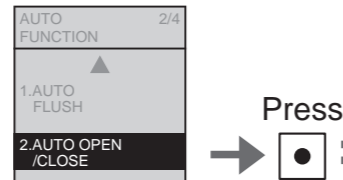
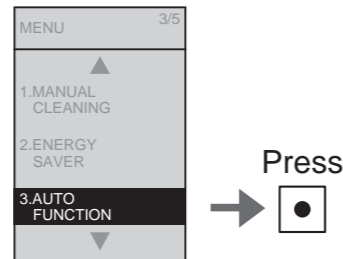

Set whether or not to open and close the toilet lid automatically
Auto open / close^{*1}

4 Select
[AUTO OPEN/CLOSE].



5 Select
[ON] or [OFF].

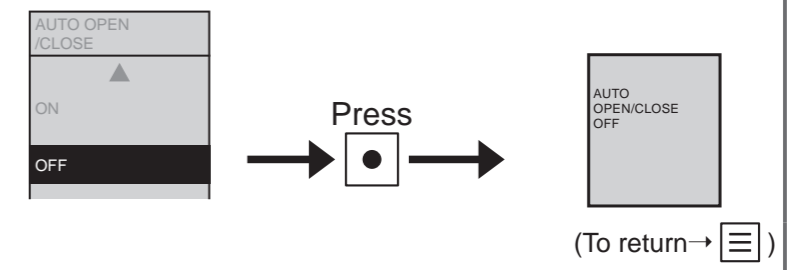

Change the amount of time before the lid/seat closes automatically
Auto close delay

4 Select
[AUTO CLOSE DELAY].

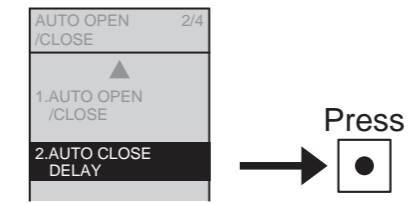

5 Select
[25S] or [90S].^{*2}

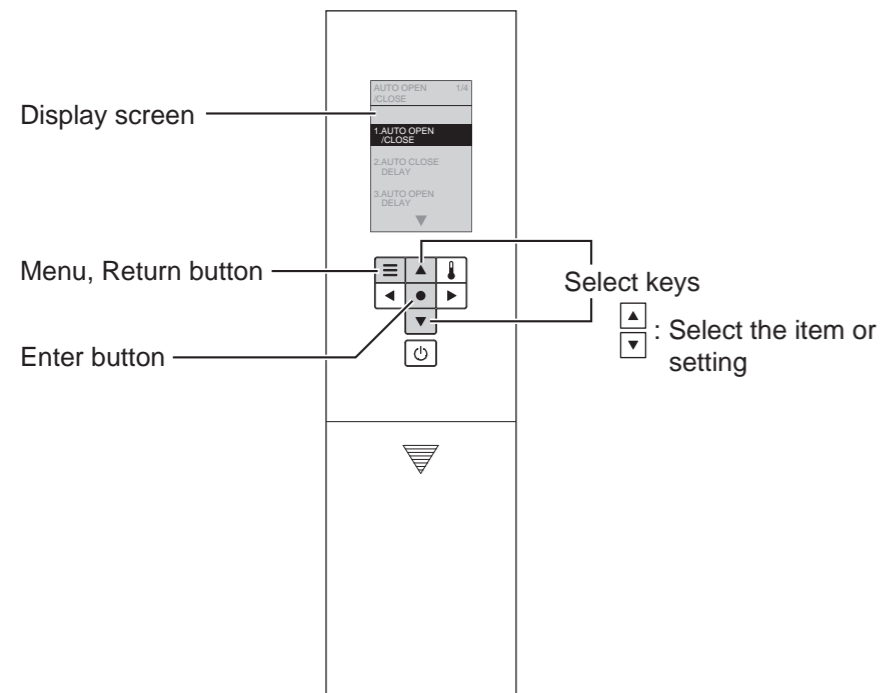
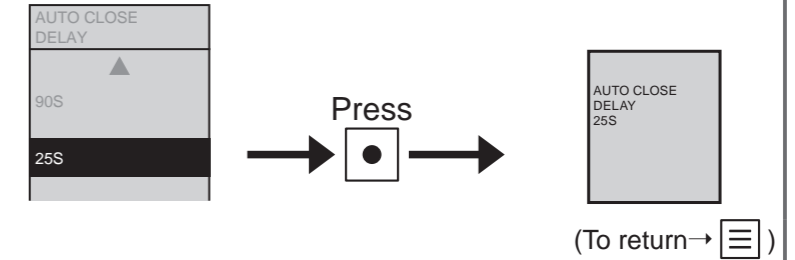

Items set on this display

1. AUTO OPEN/CLOSE
"Auto open/close"
2. AUTO CLOSE DELAY
"Auto close delay"
3. AUTO OPEN DELAY
"Auto open delay"
4. SEAT/LID
"Seat/lid"

*1 When set to "OFF", you can use the "Opening and closing the toilet seat" button on the remote to open/close the toilet lid. (Page 14)

*2 When set to "25 seconds", the lid/seat does not open automatically for about 15 seconds after closing automatically.

Changing Settings

Auto open / close (Continued)

1 Press.

2 Select
[AUTO FUNCTION].

3 Select
[AUTO OPEN/
CLOSE].

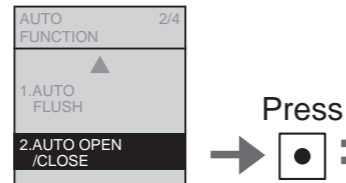
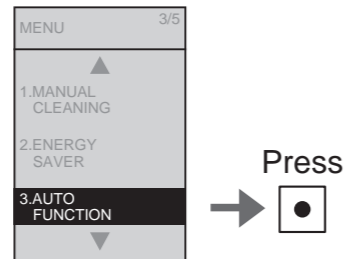

Change the time period
till automatic opening
(After closing by hand.)
**Auto open
delay**

4 Select
[AUTO OPEN DELAY].

5 Select
[15S], [30S] or [90S].

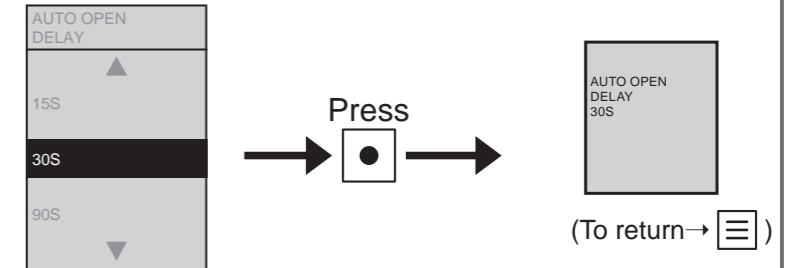
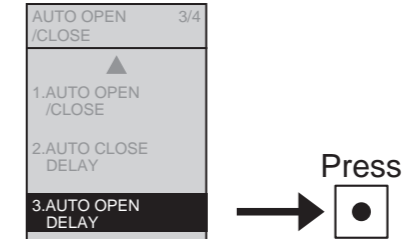

Automatically open and
close the toilet lid/
Automatically open and
close the toilet seat and
toilet lid
Seat/lid

4 Select
[SEAT / LID].

5 Select
[LID] or [SEAT·LID].*¹

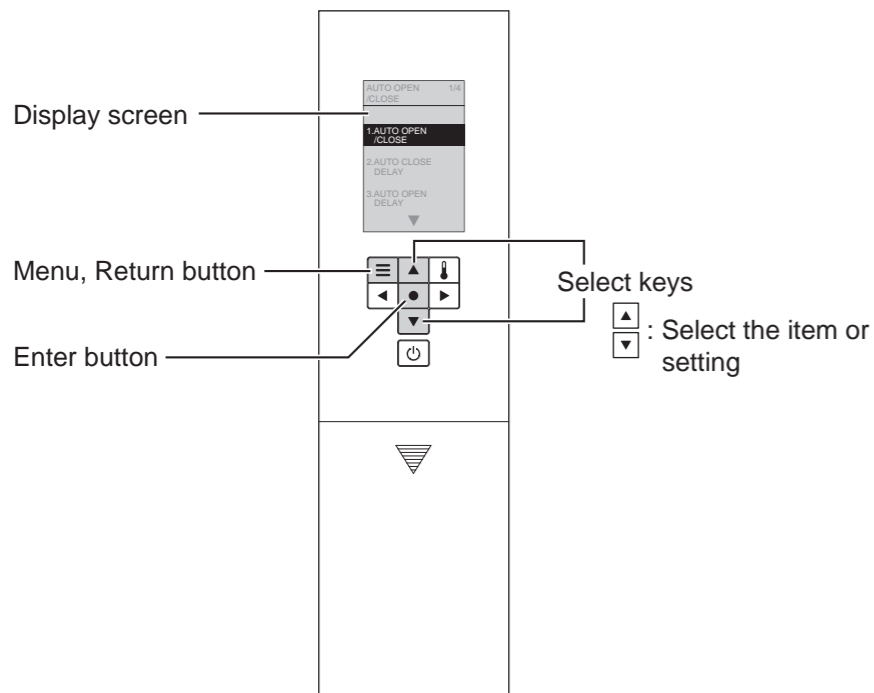
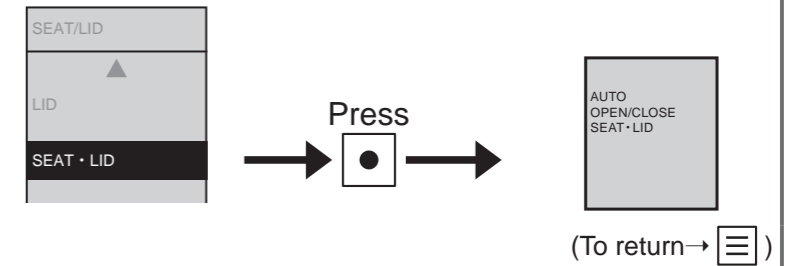
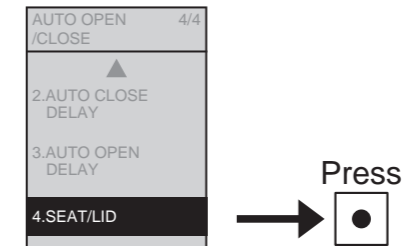

Items set on this display

1. AUTO OPEN/CLOSE
"Auto open/close"
2. AUTO CLOSE DELAY
"Auto close delay"
3. AUTO OPEN DELAY
"Auto open delay"
4. SEAT/LID
"Seat/lid"

*1 When the "Seat-lid" are set to open automatically, pre-mist is not sprayed.

Changing Settings

Cleaning Features

1 Press.

2 Select
[AUTO FUNCTION].

3 Select
[AUTO CLEANING].

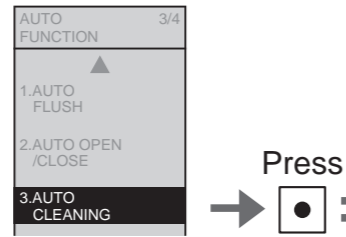
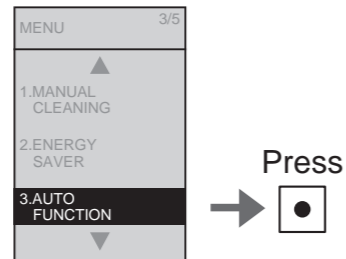

Set whether or not to clean the wand automatically

Auto wand CLEAN

4 Select
[AUTO WAND CLEAN].



5 Select
[ON] or [OFF].

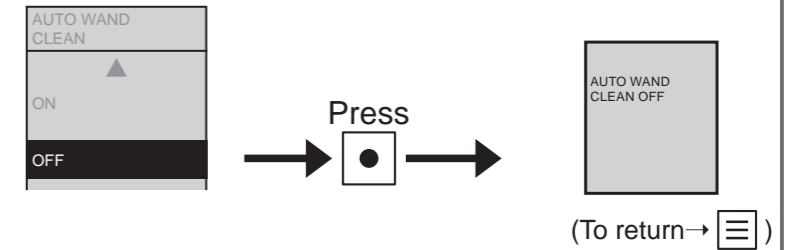

Set whether or not to spray mist in the bowl unit automatically

Auto bowl CLEAN

4 Select
[AUTO BOWL CLEAN].

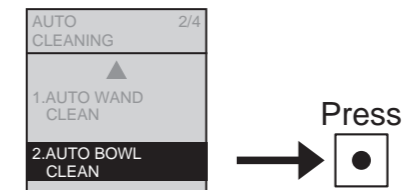

5 Select
[ON] or [OFF].

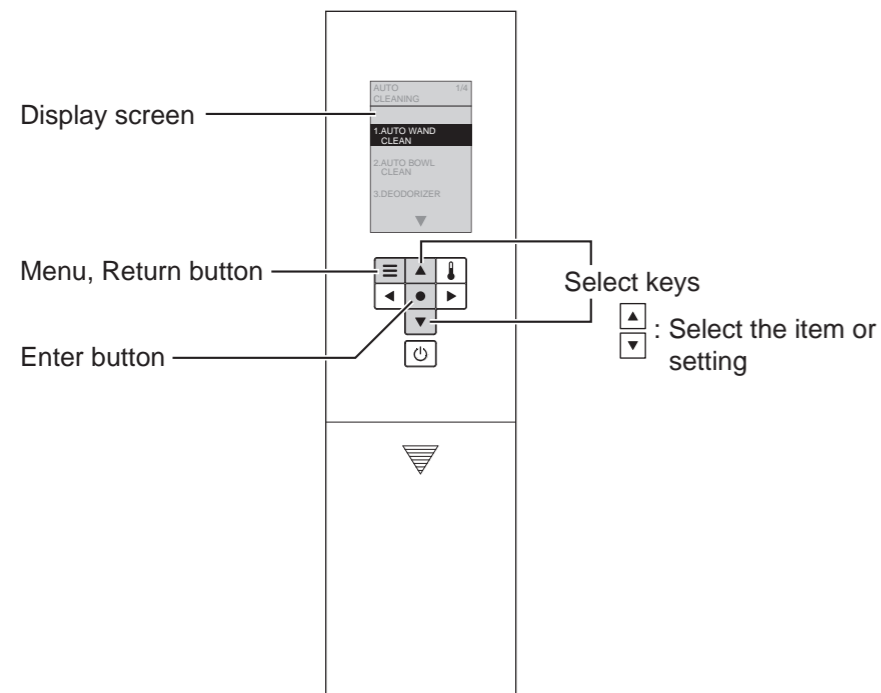
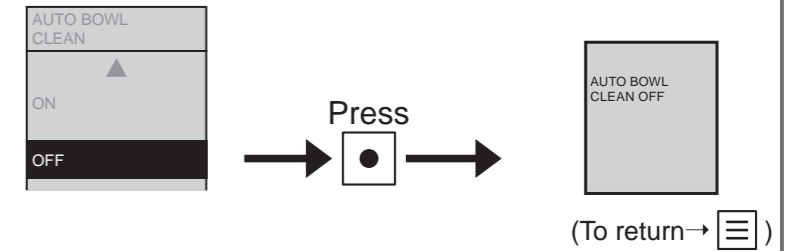

Items set on this display

1. AUTO WAND CLEAN
"Auto wand CLEAN"
2. AUTO BOWL CLEAN
"Auto bowl CLEAN"
3. DEODORIZER
"Deodorizer"
4. AUTO POWER DEODORIZER
"Auto power deodorizer"

Changing Settings

Cleaning Features (Continued)

1 Press.

2 Select
[AUTO FUNCTION].

3 Select
[AUTO CLEANING].

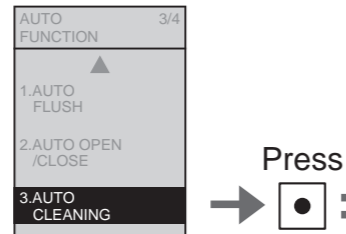
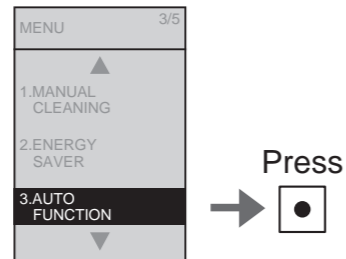

Set whether or not to deodorize automatically after sitting on the toilet seat
Deodorizer

4 Select
[DEODORIZER].

5 Select
[ON] or [OFF].

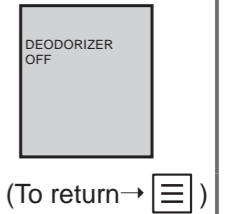
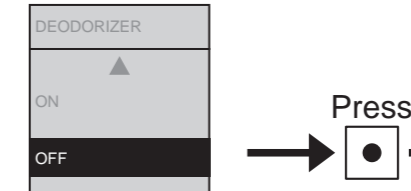
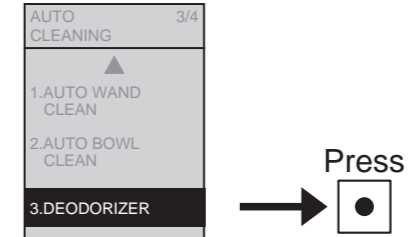

Set whether or not to power deodorize automatically after standing up
Auto power deodorizer

4 Select
[AUTO POWER DEODORIZER].

5 Select
[ON] or [OFF].

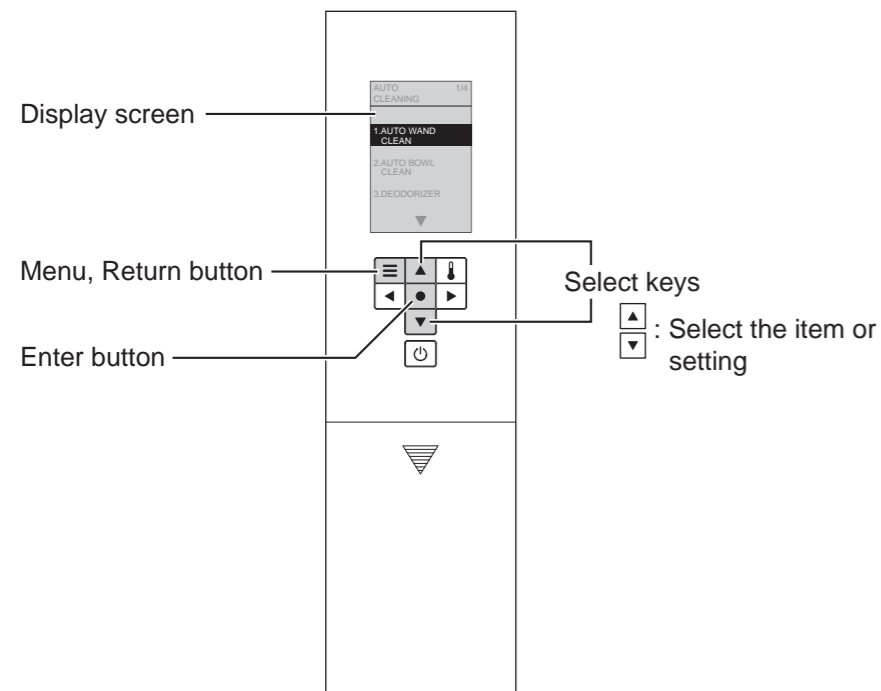
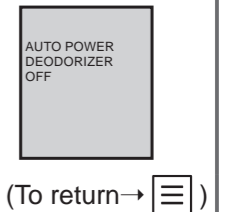
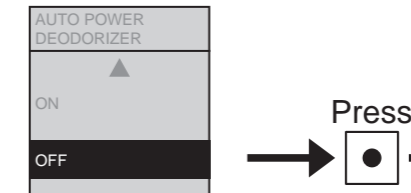
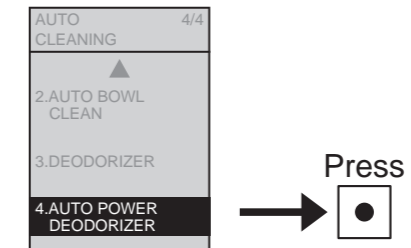

Items set on this display

1. AUTO WAND CLEAN
"Auto wand CLEAN"
2. AUTO BOWL CLEAN
"Auto bowl CLEAN"
3. DEODORIZER
"Deodorizer"
4. AUTO POWER DEODORIZER
"Auto power deodorizer"

Changing Settings

Light

1 Press.

2 Select
[AUTO FUNCTION].

3 Select
[LIGHT].

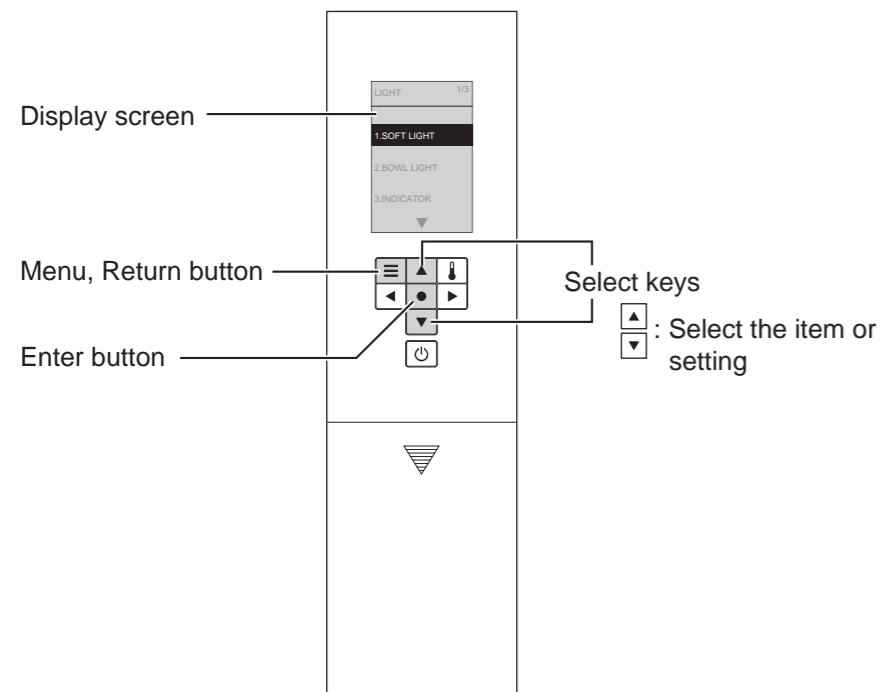
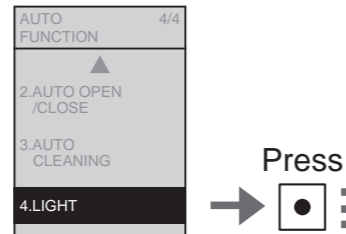
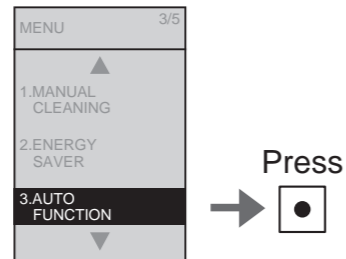

Items set on this display



1. SOFT LIGHT
"Soft light"
2. BOWL LIGHT
"Bowl light"
3. INDICATOR
"CLEAN indicator"

<p>Set whether or not to use the soft light</p> <h3>Soft light</h3>	<p>4 Select [SOFT LIGHT].</p> <p>5 Select [ON] or [OFF].</p>	
<p>Set whether or not to use the light inside the bowl unit</p> <h3>Bowl light</h3>	<p>4 Select [BOWL LIGHT].</p> <p>5 Select [ON] or [OFF].</p>	
<p>Set whether or not to light up the CLEAN indicator</p> <h3>CLEAN indicator</h3>	<p>4 Select [INDICATOR].</p> <p>5 Select [ON] or [OFF].</p>	

Changing Settings



Language settings

1  Press.

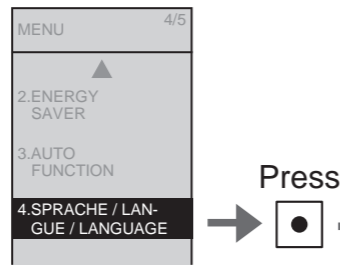
2   Select
[SPRACHE / LANGUE /
LANGUAGE].



Select the language displayed on the back of remote control
Language settings

3   Select
[DEUTSCH], [FRANÇAIS]
or [ENGLISH].

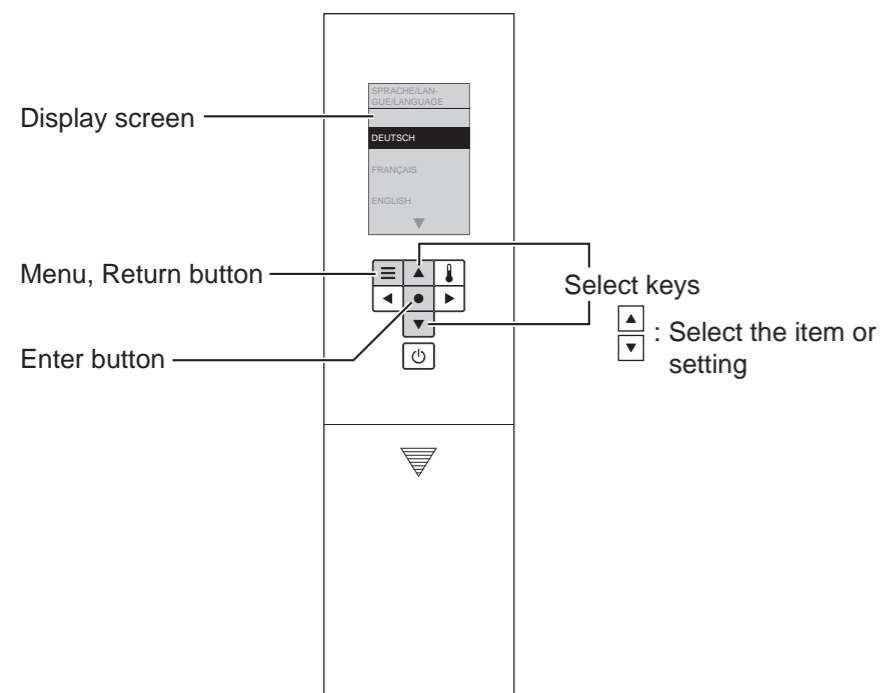
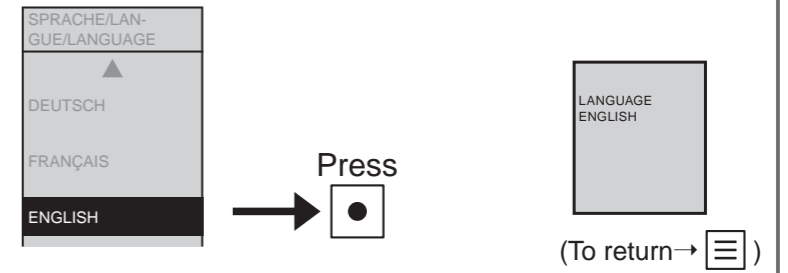

Items set on this display

1. DEUTSCH
"German"
2. FRANÇAIS
"French"
3. ENGLISH
"English"

Changing Settings

Other settings

- 1 Press.
- 2 Select [OTHER SETTING].

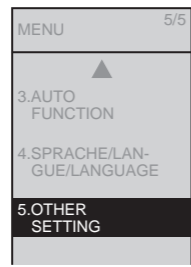

Press

Set whether or not to make a beep sound
Beep sound

- 3 Select [BEEP].

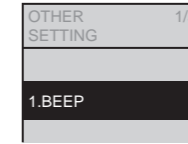

Press

- 4 Select [ON] or [OFF].

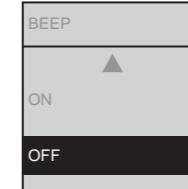

Press

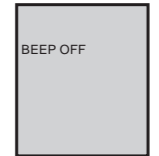

(To return →)

Set whether or not to use the setting lock
Setting lock

- 3 Select [SETTING LOCK].

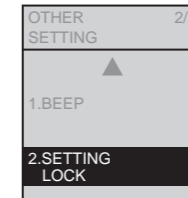

Press

- 4 Select [ON] or [OFF].

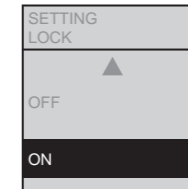

Press

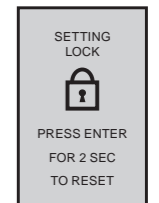

- 5 Check the displayed screen.

Display screen during setting lock



Cancellation method:
 Press "Enter" for 2 seconds or longer.

*If you want to relock after cancellation, reconfigure the setting.

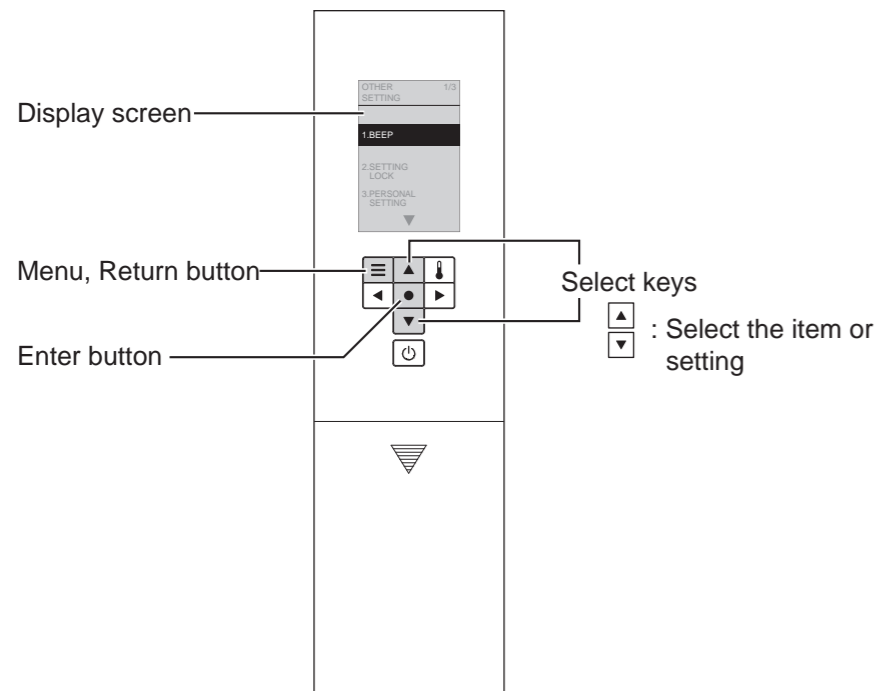

Items set on this display

1. BEEP
"Beep sound"
2. SETTING LOCK
"Setting lock"
3. PERSONAL SETTING
"Personal setting"

Changing Settings

Other settings (Continued)

1 Press.

2 Select
[OTHER SETTING].

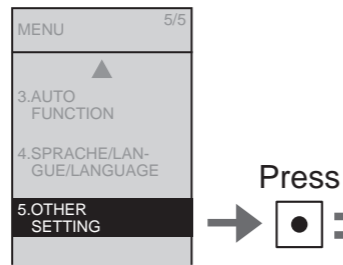

Set whether or not to use the personal setting
Personal setting
Setting

3 Select
[PERSONAL SETTING].

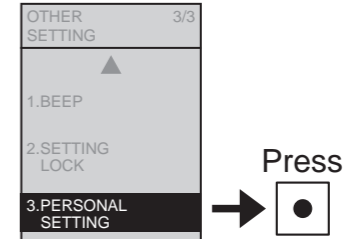

4 Select
[SETTING].

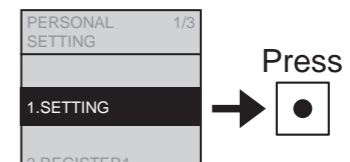

5 Select
[ON] or [OFF].

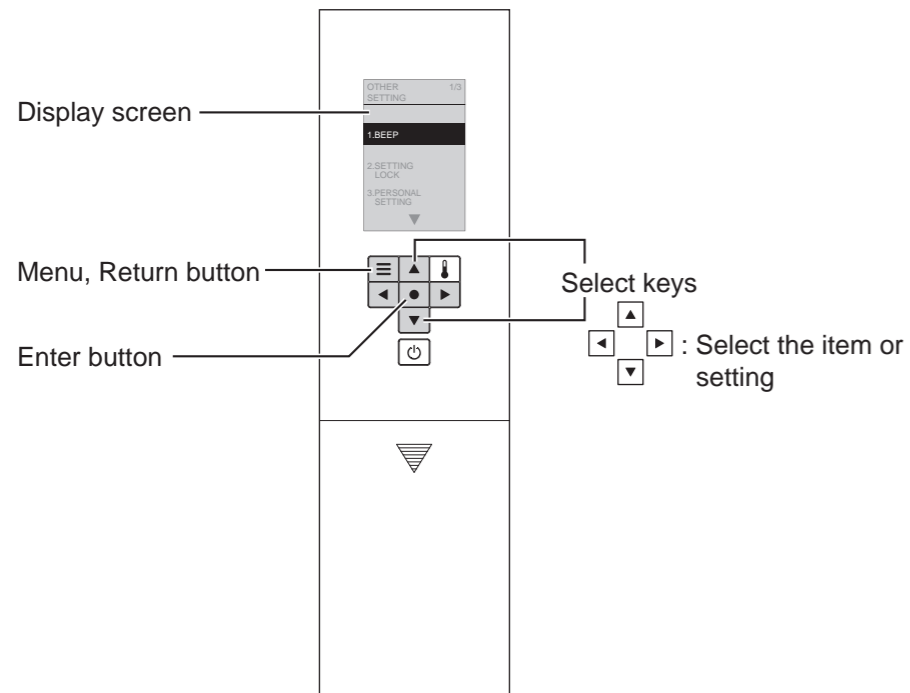
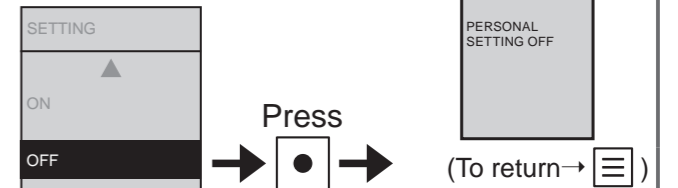

Set to remember your favorite pressure, wand position and water temperature settings
Personal setting
Register1
Register2

3 Select
[PERSONAL SETTING].

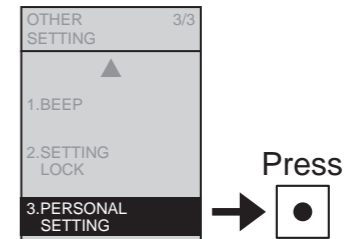

4 Select
[REGISTER1] or [REGISTER2].

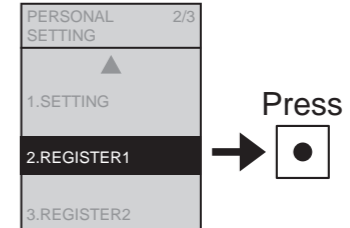

5 Select [PRESSURE] and
 Set the water pressure.

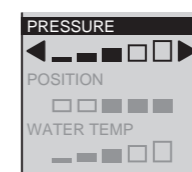

6 Select [POSITION] and
 Set the wand position.

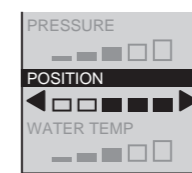

7 Select [WATER TEMP] and
 Set the water temperature.

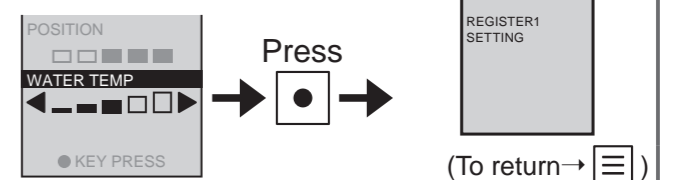

Items set on this display

- 1. BEEP
"Beep sound"
- 2. SETTING LOCK
"Setting lock"
- 3. PERSONAL SETTING
"Personal setting"

What to Do?

If the water does not flow due to a water service interruption

If you cannot operate with the remote control

If the water does not flow due to a water service interruption

1 Use a bucket to flush water.

2 If the water level is low after flushing, add more water.
• Prevents odours.

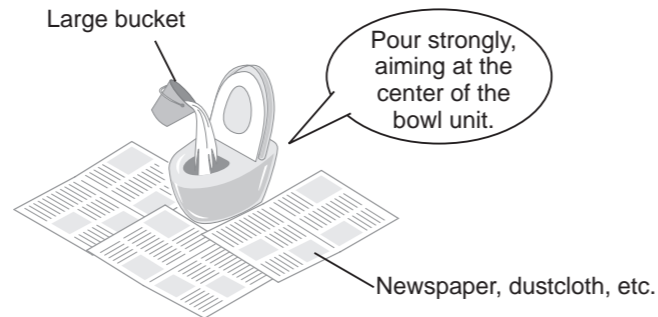

Attention!

- Before starting to work, set "Auto flushing" (Except TCF801CG) to "OFF". (Page 44)
- When water supply is restored, be sure to perform a full flush. (To prevent waste from remaining in the drain pipe.)

If you cannot operate with the remote control

● If the low battery warning mark "  " on the display screen on the back of the remote control lights up, please replace the batteries.

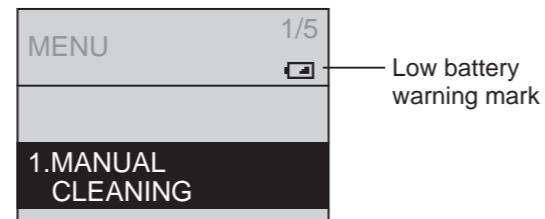

■ Replacing the batteries

1 Remove the cover on the left side of the main unit, and flip the power switch to "OFF". (Page 13)

2 Remove the remote control from the hanger. (Page 12)

3 Open the battery cover and replace the two AA batteries. (Page 12)
• The low battery warning mark goes off.

4 Mount the remote control in the hanger.

5 Flip the power switch to ON. (Page 13)
• The "Power" LED lights up.

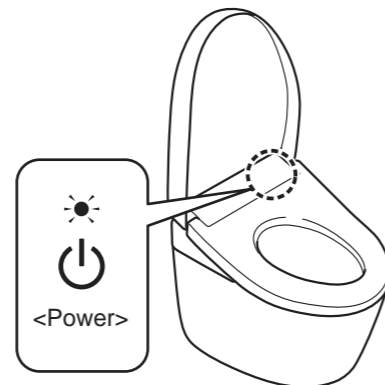

6 Reinstall the cover. (Page 29)

Attention!

- "ON" and "OFF" settings of the functions such as the energy saver function may be canceled when the batteries are replaced. Set them again.

Freeze Damage Prevention

When the ambient temperature is likely to drop to 0 °C or lower, take measures to prevent freezing.

Attention!

- When the ambient temperature is likely to drop to 0 °C or lower, do not use the energy saver feature. (May damage the product.)
- Warm the bathroom or take measures against freezing so that the ambient temperature does not drop below 0 °C.
- Before starting to work, set "Auto flushing" (Except TCF801CG) (Page 44) and "Auto open/close" (Page 46) to "OFF".

How to freeze damage prevention

1 Close the shutoff valve. (Page 67)
• The water supply stops.

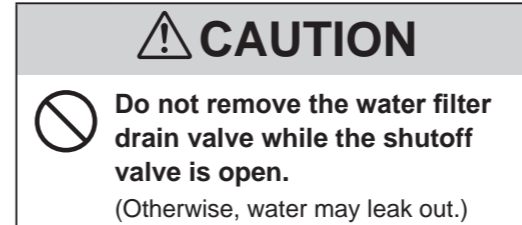

2  Press "Wand CLEAN" button. (Release the pressure from the water supply pipe.)
• Water comes out from around the wand.

3 Remove the cover on the left side of the main unit, and flip the power switch to "OFF". (Page 13)

4 Remove the water filter drain valve.
• Loosen the water filter drain valve with a flat-head screwdriver and then pull it.

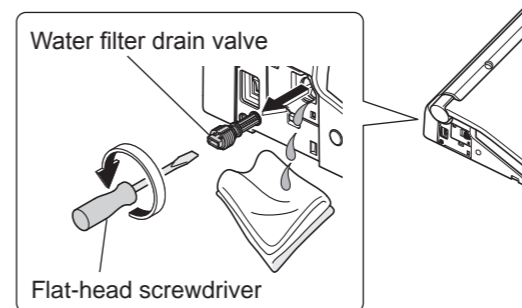

5 After draining the water, install the water filter drain valve.
• Insert the water filter drain valve and use a flat-head screwdriver to tighten it securely.

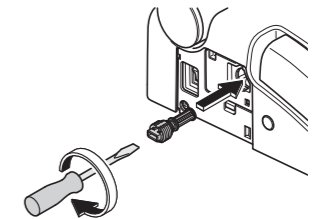

6 Flip the power switch to ON. (Page 13)
• The "Power" LED lights up.

7 Reinstall the cover. (Page 29)

8 Set the toilet seat temperature to "High". (Page 22)
• To maintain the temperature, close the toilet seat and toilet lid after finishing work.

■ To use the product again

- The water needs to be resupplied. (Page 65)

What to Do?

Long Periods of Disuse

If the toilet is in a location you will not visit for a long time, drain the water.

(The water in the tank may cause malfunctions or become contaminated and cause skin irritation or other problems.)

How to drain the water

- 1 Close the shutoff valve. (Page 67)
 - The water supply stops.

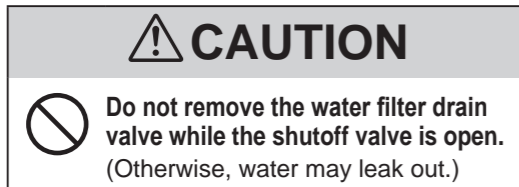

- 2 Press "Wand CLEAN" button.
(Release the pressure from the water supply pipe.)
 - Water comes out from around the wand.

- 3 Remove the cover on the left side of the main unit, and flip the power switch to "OFF". (Page 13)

- 4 Remove the water filter drain valve.
 - Loosen the water filter drain valve with a flat-head screwdriver and then pull it.

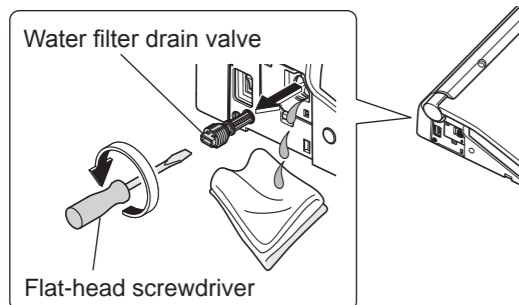

- 5 After draining the water, install the water filter drain valve.
 - Insert the water filter drain valve and use a flat-head screwdriver to tighten it securely.

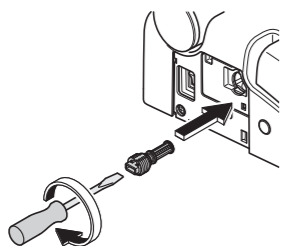

- 6 Reinstall the cover. (Page 29)

- 7 Pull out the water drain lever.
 - Water comes out from around the wand.
(about 20 seconds)

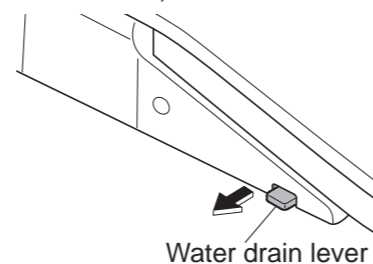

- 8 Release your hand to return the water drain lever to its original position.

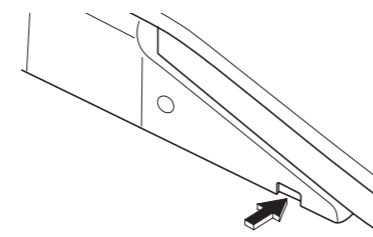

■ If water may get frozen

- Add antifreeze solution in the water in the bowl to prevent freezing.
(The antifreeze solution should not be flushed out. Collect it before using the toilet and dispose of it.)

■ To use the product again

- The water needs to be resupplied. (Page 65)

Resupplying the Water

- 1 Open the shutoff valve. (Page 13)
 - Check that water is not leaking from a pipe or the main unit.
- 2 If the power is not on,
 - (1) Remove the cover on the left side of the main unit, and flip the power switch to "ON". (Page 13)
 - The "Power" LED lights up.
 - (2) Reinstall the cover. (Page 29)

- 3 Discharge water from the wand.
 - (1) Press and hold pressure on the seat sensor with your hand or arm (see page 9 for details).
 - (2) Press "Rear cleansing" button to discharge water from the wand.
 - Catch the water in a paper cup or other receptacle.
 - (3) Press "Stopping" button.
 - **If the remaining water has frozen and no water comes out**
 - Heat the inside of the bathroom, and warm the water supply hose and shutoff valve using a cloth soaked in warm water.

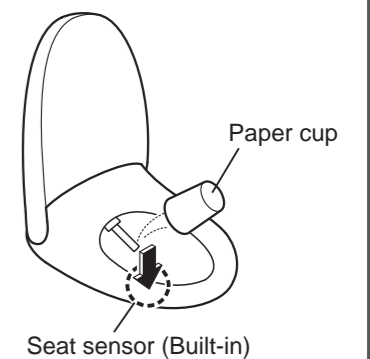

What to Do?

Removal of Operation Guide

Follow the procedure below.

How to remove the operation guide

- 1 Remove the cover on the left side of the main unit, and flip the power switch to "OFF". (Page 13)
- 2 Remove the remote control from the hanger. (Page 12)
- 3 Remove the hanger and operation guide.

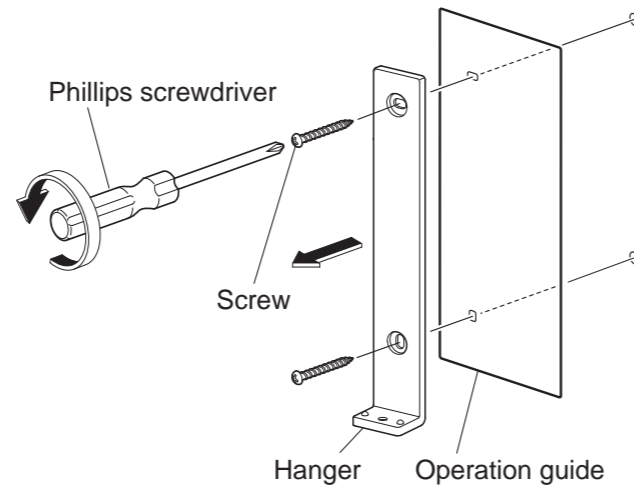

- 4 Screw the hanger on the wall.

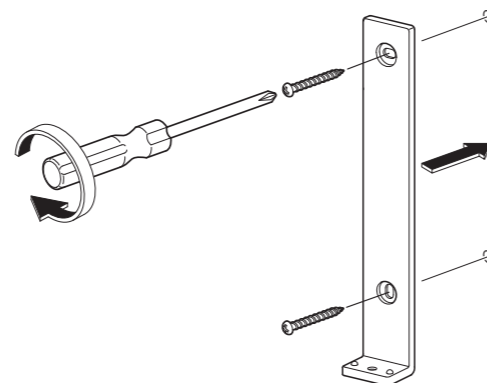

- 5 Mount the remote control in the hanger.

- 6 Flip the power switch to ON. (Page 13)
 - The "Power" LED lights up.

- 7 Reinstall the cover. (Page 29)

■ To install back the operation guide, follow the procedure above. (Install the operation guide at step 4.)

Troubleshooting

First, try the actions described on pages 67 - 73. If the problem persists, consult the installer, seller, or TOTO customer service (see contact information on the back cover).

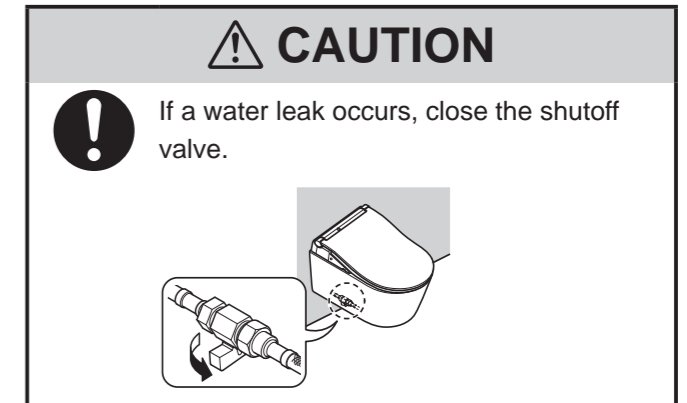

Please check first

Is the Power LED lit?

- Is the breaker on the distribution board turned on?
→ Check whether there is a power outage or the breaker has turned "OFF".
- Is the power switch flipped to "OFF"?
→ Flip it to "ON". (Page 13 Step 2-2)
- Is the "Power ON/OFF" setting "OFF"?
→ Switch it to "ON" with the remote control. (Page 13 Step 2-2)

Is the Energy saver LED lit?

- While the LED is lit, energy saver (Page 24) is in operation, so the toilet seat temperature may be reduced or the heater may be turned off.

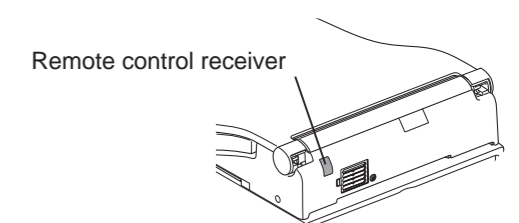
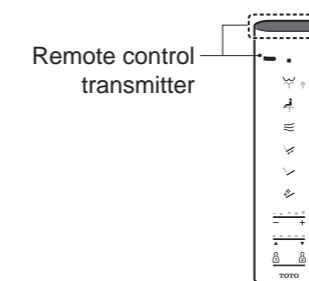
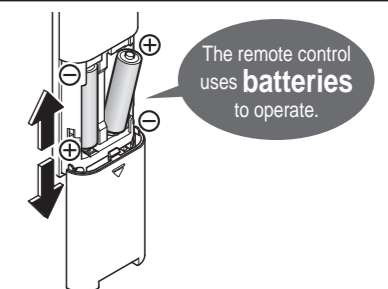

Is the remote control working?

- Does the display screen on the back of the remote show " "?
→ Replace the batteries. (Pages 12, 62)
- Is the remote control transmitter or the remote control receiver blocked?
→ Remove obstructions, dirt, water droplets or any other blockages.



Troubleshooting

Rear Cleansing, Front Cleansing and Wand

Trouble	Please check	Ref. Page
The wand (or cleansing water) does not come out	● When the temperature is low, it takes time for the wand to come out after the remote control button is pressed because the water must be warmed up first.	-
	● Did you sit on the toilet continuously for 2 hours or longer? (If so, operation is stopped for safety purposes.) → Stand up from the seat and then use again.	-
	● If the water supply pressure drops significantly, for example if water is used elsewhere or if there is a water failure, the function may stop for safety. → Flip the power switch to OFF and wait about 10 seconds before flipping it on again. If the same symptom reappears. → There may be a malfunction. Consult with TOTO customer service (see contact information on the back cover).	13
	● When sitting on the toilet seat, is there a toilet seat cover or clothing on the seat sensor? Are you sitting without touching any part of the seat sensor? → Check the position of the seat sensor, then sit so your skin is in direct contact with the seat sensor.	9
	● Are you using a toilet seat cover, a toilet lid cover or a seat for infants? → Remove any covers. When using a seat for infants or a soft highchair, remove after each use.	9
	●  Are you pressing "Wand CLEAN" button? ●  When you press "Wand CLEAN" button, "ewater+" comes out from the vicinity of the wand to clean the wand. → To clean the wand with it extended, perform "Wand cleaning".	30
The wand extends but the cleansing water does not come out / The cleansing water pressure is weak	● Has a water failure occurred? → ■ Press "Stopping" button on the remote control and wait until water service is restored.	-
	● Is the shutoff valve closed? → Fully open the shutoff valve.	13
	● Perform Descaling mode.	35
	● Is the water pressure set to a low level?	15
The cleansing water is cold	● Is the warm water temperature set to "OFF" or a low level? ● When the temperature of the water supply or the bathroom is low, the water temperature may be low when first sprayed.	22 -
Stops in the middle of use	● "Rear cleansing", "Rear soft cleansing" and "Front cleansing" stop automatically after 5 minutes of continuous use. Then the "Power" LED (Green) and the "Energy saver" LED (Green) on the display of the main unit flash about 60 seconds while hot water is prepared. → Wait until the LEDs on the display of the main unit light up solidly and then press the button again.	-
	● Does the seat sensor have difficulty detecting? → If you get up slightly from or sit towards the left of the seat, the seat sensor may temporarily stop detecting your presence.	9
Water comes out unexpectedly from the wand	● When you sit on the toilet seat, water comes out for several seconds while water is warmed up. ● Has the CLEAN indicator light up in a cycle? ● "Auto wand CLEAN" starts and the wand is cleaned.	- 18



Warm air drying

Trouble	Please check	Ref. Page
The dryer temperature is low	● Is the dryer temperature set to low level?	22
Stops in the middle of use	● The feature stops automatically after about 10 minutes of continuous use. ● Does the seat sensor have difficulty detecting? → If you get up slightly from or sit towards the left of the seat, the seat sensor may temporarily stop detecting your presence.	- 9

Flushing*1

Trouble	Please check	Ref. Page
For not flushing	● Are the main tap and the in-wall tank's shutoff valve fully open?	-
	● Has a water failure occurred? → Use a bucket to flush water.	62
The toilet does not flush even when the button is pressed	● Are you pressing the button repeatedly? (After pressing the flush button, operation will not be accepted for about 10 to 20 seconds.)	-
The bowl unit does not clean automatically or the timing is delayed (Auto flushing)	● Is "Auto flushing" set to "OFF"? → Set to "ON". ● Even if "Auto flushing" is set to "ON", it is not available in the following instances. ● About 60 seconds after the toilet is flushed. → Wait about 60 seconds and flush the toilet with the remote control. ● When the time spent sitting on the toilet seat or standing in front of the bowl unit is less than about 6 seconds. → Flush with the remote control.	44 20 20
	● When staying in front of the bowl unit after standing and using the toilet. → Step away from the toilet and wait for about 3 seconds. ● When water droplets or dirt are disrupting the body sensor. → Remove the dirt. ● When sitting on the toilet seat, is there a toilet seat cover or clothing on the seat sensor? Are you sitting without touching any part of the seat sensor? → Check the position of the seat sensor, then sit so your skin is in direct contact with the seat sensor.	- 9
	● The timing for the "Auto flushing" can be changed. (After about 10 seconds → after about 5 or 15 seconds)	44
	● Is "Auto flushing" set to "ON"? → You can turn it "OFF". ● Does the seat sensor have difficulty detecting? → If you get up slightly from or sit towards the left of the seat, the seat sensor may not detect, and thus auto flushing may occur during use.	44 9

*1 Except TCF801CG

Troubleshooting

Toilet Seat and Toilet Lid (Auto open/close)

Trouble	Please check	Ref. Page
The toilet lid does not open automatically	<ul style="list-style-type: none"> ● Is "Auto open/close" set to "OFF"? →Set to "ON". ● Even when set to "ON", "Auto open/close" is not performed for about 15 seconds after the toilet seat or toilet lid is closed. <ul style="list-style-type: none"> • When the toilet lid is closed by hand (To make the product more user-friendly, a time interval is set from when the lid is closed to when it will open next.) →Move away from the toilet and wait at least about 15 seconds before approaching the bowl unit again or open and close by hand. 	46
	<ul style="list-style-type: none"> ● Is "Auto open delay" set to "30 seconds" or "90 seconds"? 	48
	<ul style="list-style-type: none"> ● After flip the power switch to "ON", the toilet lid does not open automatically for about 10 to 60 seconds. →Open and close by hand. 	-
	<ul style="list-style-type: none"> ● Is a toilet lid or seat cover installed? →Remove any covers. 	9
	<ul style="list-style-type: none"> ● Detection by the body sensor may be difficult when the toilet is used by someone small, such as a child. 	-
The toilet lid does not close automatically	<ul style="list-style-type: none"> ● Is "Auto open/close" set to "OFF"? →Set to "ON". ● In the following cases, the toilet lid closes in about 5 minutes. <ul style="list-style-type: none"> • When you did not sit on the toilet seat • When you sat on the toilet seat for less than 6 seconds • When you stood in front of the bowl unit for less than 6 seconds ● If they do not close automatically even though "Auto open/close" is set to "ON", the body sensor may be detecting incorrectly. →If there is a reflective object in front, such as a mirror or glass, move the reflective object or use a curtain or other object to block it. 	46
	<ul style="list-style-type: none"> ● Is "Auto close delay" set to "25 seconds"? 	46
	<ul style="list-style-type: none"> ● When sitting on the toilet seat, is there a toilet seat cover or clothing on the seat sensor? Are you sitting without touching any part of the seat sensor? →Check the position of the seat sensor, then sit so your skin is in direct contact with the seat sensor. 	9
The toilet lid opens on its own	<ul style="list-style-type: none"> ● Is the body sensor directly exposed to sunlight? →Do not directly expose the body sensor to sunlight, because it may cause incorrect detection. ● Is there a heater within the detection range of the body sensor? →Do not place within the detection range of the body sensor. ● Is a urinal or wash basin also installed in the bathroom? →The sensor may detect someone using the urinal, causing the toilet lid to open or close. ● When the bathroom door is open, the sensor may detect people who pass in front of the toilet. 	9
The toilet lid closes on its own	<ul style="list-style-type: none"> ● Is "Auto open/close" set to "ON"? →You can turn it "OFF". 	46
	<ul style="list-style-type: none"> ● Is "Auto close delay" set to "25 seconds"? ● When sitting on the toilet seat, is there a toilet seat cover or clothing on the seat sensor? Are you sitting without touching any part of the seat sensor? →Check the position of the seat sensor, then sit so your skin is in direct contact with the seat sensor. 	9
The toilet lid and toilet seat open at the same time	<ul style="list-style-type: none"> ● Is "Seat/lid" set to "Seat-lid"? 	48
Stops (or closes) while opening	<ul style="list-style-type: none"> ● If the lid or seat hits an obstruction the first time it opens after flip the power switch to "ON", it may stop (or close) partway during the next operation. →Eliminate any obstructions and flip the power switch to "OFF". Switch it to ON again after about 5 seconds. Then press the  "Opening and closing the toilet seat" button. 	13
		14
The open timing has changed.	<ul style="list-style-type: none"> ● Detection by the body sensor may be difficult when the room temperature exceeds about 30 °C, such as in the summertime. 	9

Toilet Seat and Toilet Lid

Trouble	Please check	Ref. Page
The toilet seat is cold	<ul style="list-style-type: none"> ● Is the toilet seat temperature set to "OFF" or a low level? 	22
	<ul style="list-style-type: none"> ● Is energy saver in operation? <ul style="list-style-type: none"> • The energy saver feature is on when the "Energy saver" LED is on and the "Power" LED is off on the main display. When you sit on the seat, the toilet seat heater is turned on temporarily and the seat is warmed in about 15 minutes. →You can turn it "OFF" if the energy saver feature is "ON". 	24
	<ul style="list-style-type: none"> ● Have you been seated for a long time? <ul style="list-style-type: none"> • After about 20 minutes of sitting, the temperature starts going down, and after about 1 hour, the toilet seat heater is turned "OFF". →Stand up from the seat and then use again. 	26
	<ul style="list-style-type: none"> ● Is a toilet lid or seat cover installed? →Remove any covers. 	9
Cannot open or close with the remote control	<ul style="list-style-type: none"> ● If it opens automatically →Check "Is the remote control working?" ● If automatic opening does not work either <ul style="list-style-type: none"> • The toilet lid may not be mounted correctly. →Mount them correctly. ● Incorrect detection may occur when operating under fluorescent lights. 	67
The toilet lid opens/closes when you press the "Opening and closing the toilet seat" button on the remote.	<ul style="list-style-type: none"> ● Is "Auto open/close" set to "OFF"? <ul style="list-style-type: none"> • When "Auto open/close" is set to "OFF", the "Opening and closing the toilet seat" button only opens/closes the toilet lid. Press the "Opening and closing the toilet seat" button for longer than 1 second to open/close the toilet seat. ● You can change the setting "Auto open/close" to "ON", to open both, lid and seat, when pressing "Opening and closing the toilet seat" button. 	34
		46

Energy Saver

Trouble	Please check	Ref. Page
The Energy saver LED does not light up	<ul style="list-style-type: none"> ● Did you flip the power switch to OFF, or was there a power outage? <ul style="list-style-type: none"> • The "Energy saver" LED on the main display may go off when the power is turned on even if the energy saver feature is "ON". (It will turn on within about 24 hours since the setting is retained.) 	-
The timer energy saver feature is not working	<ul style="list-style-type: none"> ● Did you replace the remote control batteries? <ul style="list-style-type: none"> • "Timer energy saver" may be canceled when the batteries are replaced. →Set the timer energy saver again at the time you want to start it. 	26
The auto energy saver+ or auto energy saver feature is not working	<ul style="list-style-type: none"> ● Because the function takes several days learning the usage conditions before starting energy saver, the amount of energy saving may be low, depending on the frequency of use. →Check the energy saver setting. 	24

Troubleshooting

Deodorizer

Trouble	Please check	Ref. Page
The deodorizer seems to be not working	<ul style="list-style-type: none"> ● Is "Deodorizer" set to "OFF"? →Set to "ON". 	52
	<ul style="list-style-type: none"> ● Even after sitting down, you do not hear operation sounds. →Sit back on the toilet seat. 	9
	<ul style="list-style-type: none"> ● If you hear an operation sound from the deodorizer, but odours are not removed. →Clean the deodorizing filter. 	31
A strange odor is emitted	<ul style="list-style-type: none"> ● Are you using an air freshener or deodorizer that you purchased separately? <ul style="list-style-type: none"> • Doing so may reduce the effectiveness of the product deodorizer or cause strange odours. →Remove the air freshener or deodorizer. 	-
The auto power deodorizer feature is not working	<ul style="list-style-type: none"> ● Is "Auto power deodorizer" set to "OFF"? →Set to "ON". ● It starts about 10 seconds after you stand up from the toilet seat. 	52 -

Sanitary

Trouble	Please check	Ref. Page
The soft light, bowl light and CLEAN indicator do not light up	<ul style="list-style-type: none"> ● Is the setting "OFF"? → Set to "ON". ● If the "CLEAN indicator" does not light up, it is time for parts replacement. Consult the installer, seller, or TOTO customer service (see contact information on the back cover). 	54 -
Pre-mist and after-mist do not work	<ul style="list-style-type: none"> ● Is "Auto bowl CLEAN" set to "OFF"? →Set to "ON". 	50
	<ul style="list-style-type: none"> ● The following functions do not work when the toilet seat is open. <ul style="list-style-type: none"> • Is "Seat/lid" of "Auto open/close" set to "Seat•lid"? →You can change it to "Lid". 	48
	<ul style="list-style-type: none"> ● The pre-mist does not work for about 90 seconds after the after-mist has finished. ● Perform Descaling mode. 	- 35
The mist sprays out spontaneously	<ul style="list-style-type: none"> ● When body sensor A detects someone, the "Auto bowl CLEAN" function activates and pre-mist is sprayed. →You can switch "Auto bowl CLEAN" to OFF. 	18 50
	<ul style="list-style-type: none"> ● If the cleansing functions (e.g., Rear cleansing and Front cleansing) are not used for about 8 hours, "Auto bowl CLEAN" starts and mist is sprayed inside the bowl unit. 	19
Pre-mist / after-mist is weak	<ul style="list-style-type: none"> ● Perform Descaling mode. 	35

Others

Trouble	Please check	Ref. Page
Water is leaking from the plumbing connections	<ul style="list-style-type: none"> ● If any nuts in a connection are loose, firmly tighten them with a tool such as a monkey wrench. →If the water leak does not stop, close the shutoff valve and consult with TOTO customer service (see contact information on the back cover). 	-
The display on the remote control goes out	<ul style="list-style-type: none"> ● The display goes out when no button on the remote control is pressed for about 60 seconds or more. 	12
The main unit makes a sound	When entering the bathroom	
	<ul style="list-style-type: none"> ● If "Auto bowl CLEAN" is "ON", you may hear that pre-mist is spraying mist in the bowl unit to make it more difficult for dirt to adhere. →You can turn it "OFF". 	50
	When sitting on the toilet seat	
	<ul style="list-style-type: none"> ● You may hear the sound of water being warmed up. 	-
	When the toilet is occupied	
	<ul style="list-style-type: none"> ● You hear an operation sound at intervals of a few seconds when the cleaning feature is working properly. 	-
	When moving away from the bowl unit after use	
	<ul style="list-style-type: none"> ● When "Auto power deodorizer" is "ON", operation sounds are made while the deodorizing power increases for 60 seconds after you stand up from the toilet seat. →You can turn it "OFF". ● If "Auto wand CLEAN" is "ON" and you use the cleansing functions (e.g.,Rear cleansing and Front cleansing), you may hear that the wand is extended and cleaned with "ewater+". →You can turn it "OFF". ● If "Auto bowl CLEAN" is "ON" and you sit on the toilet seat and use the toilet, you may hear that mist of "ewater+" is sprayed inside the bowl unit. →You can turn it "OFF". ● You may hear that the wand is extended and the remaining water in the product is drained when "Auto wand CLEAN" and other functions are performed. ● You may hear the sound of the remaining water being drained. ● You may hear the fan ventilating the unit. (About 30 minutes) 	18 52 18 50 18 50 - - -
	When not using the product (e.g., at night)	
	<ul style="list-style-type: none"> ● You may hear the following sounds if "Auto wand CLEAN" or "Auto bowl CLEAN" is "ON" and if you do not use the cleansing functions (e.g.,Rear cleansing and Front cleansing) for about 8 hours. <ul style="list-style-type: none"> "Auto wand CLEAN" : Sound of cleaning the wand with "ewater+" : Sound of extending the wand and draining remaining water from the product after operation of functions "Auto bowl CLEAN" : Sound of spraying mist of "ewater+" mist inside the bowl unit →You can turn it "OFF". 	50
"Power" LED (orange) and "Energy saver" LED (orange) on product main body are flashing	<ul style="list-style-type: none"> ● If the "Power" LED (orange) and "Energy saver" LED (orange) LEDs flash at the same time, it is time to perform Descaling mode. →Perform Descaling mode. 	35

Specifications

Item		TCF802C2G TCF801CG	
Rated power supply		AC 220 - 240 V, 50 Hz	
Rated power consumption		844 - 854 W	
Maximum power consumption		1455 - 1468 W <When the water supply temperature is 0 °C>	
Type of water heater		Instantaneous type	
Power cord length		0.9 m	
Water protection level		IPX4	
Cleansing	Spray volume	Rear cleansing	Approx. 0.27 - 0.43 L/min. <at 0.20 MPa water pressure>
		Rear soft cleansing	Approx. 0.27 - 0.43 L/min. <at 0.20 MPa water pressure>
		Front cleansing	Approx. 0.29 - 0.43 L/min. <at 0.20 MPa water pressure>
	Water temperature		Adjustable temperature range: OFF, about 30 - 40 °C
	Heater capacity		1200 - 1428 W
	Safety device		Temperature fuse
Backflow prevention device		Air gap (according to EN1717), Vacuum breaker	
Heated seat	Surface temperature		Adjustable temperature range: OFF, about 28 - 36 °C (Auto energy saver: about 26 °C, Auto energy saver+: OFF)
	Heater capacity		55 - 65 W
	Safety device		Temperature fuse
Deodorizer	Method		O ₂ deodorization
	Airflow volume		Normal mode: Approx. 0.09 m ³ /min, Power mode: Approx. 0.16 m ³ /min
	Power consumption		Normal mode: Approx. 1.7 W, Power mode: Approx. 5.3 W
Warm air dryer	Warm air temperature ^{*1}		Adjustable temperature range: about 37 - 55 °C
	Airflow volume		Approx. 0.29 m ³ /min
	Heater capacity		200 - 238 W
	Safety device		Temperature fuse
Water supply pressure		Minimum required water pressure: 0.1 MPa <dynamic>, Maximum water pressure: 1.0 MPa <static>	
Water supply temperature		0 - 35 °C	
Working ambient temperature		0 - 40 °C	
Dimensions		W 391 mm x D 579 mm x H 108 mm	
Weight		About 8 kg	

*1 Temperature around the warm air outlet measured by TOTO.

Safety Guidelines

A warm-water cleaning toilet seat is an electric appliance.

Continued use after malfunction occurs or use when its life-time is expired may deteriorate the electric components, producing smoke or resulting in a fire.

For safe use of the warm-water cleaning toilet seat



If any abnormality of the product is observed, stop using it and consult the installer, seller or the contact listed on the back cover of this manual.

(A damaged product may cause a fire, electric shock, or may flood the floors with water.)

•Turn off the power immediately and close the shutoff valve.

Warranty

MANUFACTURER'S GUARANTEE OF TOTO EUROPE GMBH

1. The guarantee of TOTO Europe GmbH

TOTO Europe GmbH (hereinafter referred to as "TOTO") provides a guarantee such that the products it markets shall be free of manufacturing errors in the case of normal use and service for a period of two years from the date of purchase. This guarantee only applies to ultimate consumers.

"Ultimate consumer" within the meaning of this guarantee is any natural person who has entered into a legal transaction for a purpose that can neither be attributable to their commercial nor professional activity and who does not wish to sell the product to other parties.

This guarantee does not affect the ultimate consumer's contractual or statutory rights in dealings with the affected seller and the statutory rights of the ultimate consumer in dealings with the product manufacturer.

Performed repairs that were authorised by TOTO, or any exchange of products or product parts, shall not lead to an extension of the guarantee period and furthermore shall not lead to the guarantee period starting afresh including insofar as these guarantee conditions are included with the substitute product.

2. Guarantee

TOTO provides a guarantee such that the TOTO products are free of manufacturing errors. The assessment whether or not a product is faulty is based on the level of technology at the time of manufacture.

TOTO's obligations in accordance with this guarantee are limited, at TOTO's discretion, to the repair or replacement of products or product parts that are considered faulty by TOTO on condition that such products were installed and used in accordance with the instructions for use issued in conjunction with the product and in compliance with all acknowledged demands placed on professional installation. TOTO reserves the right to conduct such investigations that appear necessary to establish the cause of the fault. TOTO shall not charge the ultimate consumer for the cost of the repair, the products or parts of products as part of repairs covered by the guarantee or products that are replaced under the guarantee.

3. Preconditions to be met to activate the guarantee

The invoice must be made available to TOTO, for example as a copy, stating the date of purchase, the invoice number, name and address of the ultimate consumer as well as the name and address of the seller for a guarantee claim to be valid. TOTO may request that the ultimate consumer provide photographs that either illustrate the damage and/or the type of connections to the power network or to the fresh and industrial water supply lines. Insofar as TOTO requests this, such photographs must also be presented to render the guarantee valid. A claim based on this guarantee takes for granted that the products for which notification of defects has been provided were installed and used properly and in accordance with the instructions, which TOTO includes in the product delivery, and in this respect the corresponding laws and other legal provisions have been complied with.

If the ultimate consumer claims that the purchased product is faulty, in the event of purchase from an installer, the ultimate consumer is to contact such an installer. In all other cases, the ultimate consumer may contact his/her respective seller or a Service Center authorised by TOTO or contact TOTO itself. Notification of the defect is to be given within a reasonable short period once the defect is identified, at the latest however before the guarantee expires.

4. Guarantee exclusion

This guarantee does not apply to the following points:

- a) Damage or loss as a result of fire, earthquake, flood, storm or other cases of force majeure, emissions, gas damage (hydrogen sulphide), damage caused by salt or abnormal voltage,
- b) Damage or loss as a result of installation not in accordance with the conditions for use or not in accordance with acknowledged demands placed on professional installation; improper, wrong or inappropriate use or failure to follow the TOTO conditions for use or labels on the product or inappropriate product maintenance contrary to the conditions for use,
- c) Damage or loss as a result of altering, dismantling or destroying the product,
- d) Damage or loss as a result of sedimentation or foreign bodies in the water system,
- e) Damage or loss as a result of the water quality in the region in which the product is used,
- f) Damage or loss as a result of relocation following installation or due to a detrimental environment,
- g) Damage or loss caused by circumstances that do not involve the product itself, for example as a result of intervention in the building structure,
- h) Damage or loss caused by bites from animals or insects such as mice or residues of dead animals or insects,
- i) Damage or loss as a result of freezing the product,
- j) Damage or loss as a result of improper energy supply, which in terms of the voltage, frequency or safety fuses does not comply with the regulatory requirements for power supply in a household or electro-magnetic waves that are caused outside the product such as power lines and peripheral devices,
- k) Damage or loss as a result of attaching the product in moving vehicles such as cars and ships,
- l) Damage or loss as a result of using batteries etc.,
- m) Damage or loss as a result of wear-and-tear of items subject to day-to-day servicing (e.g. deodorizing filter, water drain plug),
- n) If spare parts other than original TOTO spare parts are used during repairs or maintenance of the product,
- o) The fault was caused by the transportation or installation of the product,
- p) The product is a demonstration product/viewing product/former demonstration product/former viewing product,
- q) If consumables (e.g. filters, filter cartridges or batteries) or materials subject to customary wear-and-tear (such as seals or hoses) are affected,
- r) If the fault was caused by the breakage of brittle parts (e.g. sensor windows or small flaps),
- s) If the fault is attributable to the fact that the product damage was caused intentionally or gross negligently by the ultimate consumer or a third party.

In each individual case, TOTO shall assess whether or not the ultimate consumer has a guarantee claim. If TOTO considers the asserted claim to be justified, and examines the affected product for that reason and thereupon it becomes clear that the product was not faulty or a guarantee claim did not apply, TOTO reserves the right to invoice the ultimate consumer for the costs that arise as a result of a visit by TOTO, or a company commissioned by TOTO, to the ultimate consumer and as a result of the rendered or intended services. If the ultimate consumer can furnish proof that the ultimate consumer could not have been aware that the preconditions for a claim were not met, TOTO shall not invoice the ultimate consumer for its visit to the ultimate consumer and the rendered or intended services. In the event that TOTO does not rectify the defect based on the guarantee, TOTO shall invoice the ultimate consumer for the costs that are actually incurred (material, labour and travelling). In the event that the ultimate consumer holds the view that he/she has additional claims as a result of other guarantees, the ultimate consumer is to establish the probable validity of its claim and TOTO shall review such claims.

5. Geographical scope of the guarantee

This guarantee is valid exclusively in the European Union and in Switzerland. If a product is installed in a European Union country in which TOTO neither has a marketing company nor a distribution partner, in respect of reviewing the guarantee activating event the ultimate consumer is to propose an installation company that satisfies comparable quality requirements.

6. Applicable law

This guarantee is subject to the law of the Federal Republic of Germany with the exception of the requirements on application of international private law and the UN Sales Law.

THIS WRITTEN WARRANTY IS THE ONLY WARRANTY MADE BY TOTO. REPAIR OR REPLACEMENT AS PROVIDED UNDER THIS WARRANTY SHALL BE THE EXCLUSIVE REMEDY AVAILABLE TO THE ULTIMATE CONSUMERS. TOTO SHALL NOT BE RESPONSIBLE FOR LOSS OF USE OF THE PRODUCT OR FOR OTHER INCIDENTAL, SPECIAL, OR CONSEQUENTIAL DAMAGE OR EXPENSES INCURRED BY PURCHASER, OR FOR LABOR OR OTHER COSTS DUE TO INSTALLATION OR REMOVAL, OR COSTS OF REPAIRS BY OTHERS, OR FOR ANY OTHER EXPENSE NOT SPECIFICALLY STATED ABOVE.

TOTO Europe GmbH
Zollhof 2
40221 Düsseldorf
Germany

Important User Guidance Information

MEMO



If you want to dispose this product, do not mix it with general household waste. There is a separate collection system for used electronic products in accordance with legislation that requires proper treatment, recovery and recycling.

Private households in the member states of the EU, Switzerland and Norway may return their used electronic products free of charge to designated collection facilities or to a retailer (if you purchase a similar new one).

For countries not mentioned above, please contact your local authorities for the correct method of disposal.

By doing so you will ensure that your disposed product undergoes the necessary treatment, recovery and recycling, which prevent potential negative effects on the environment and human health.

Only discard discharged batteries. They should not be disposed of with household waste, but rather at appropriate collection sites or at the product retailer.