

WASHLET™

Where hygiene
meets comfort.



hygiene
mygiene



Issue April 2022

TOTO

WELLNESS



WARM WATER NOZZLE

An individually adjustable wand system with self-cleaning function

CLEANLINESS



ACTILIGHT

Zirconium coating combined with UV light for a cleansing effect that breaks down waste



EWATER+

Electrolysed water with a waste-repellent, cleansing effect



PREMIST

Mist of water sprayed onto the ceramic before the toilet is used. Makes it more difficult for dirt and waste to accumulate



TORNADO FLUSH

Highly effective two- or three-jet flush



RIMLESS DESIGN

Ceramic toilet bowl without hard-to-reach areas along the top edge



CEFIONTECT

Smooth glaze for a special hygienic ceramic surface

SUSTAINABILITY



WATER-SAVING

Technologies that save water



4,5L FLUSH

Water-saving full flush uses just 4.5l

COMFORT



AUTO FUNCTIONS

Sensor-based technologies



HEATED SEAT

Individually adjustable temperature



DEODORIZER

Filter system to absorb odours



DRYER

Jet of warm air

DESIGN



INTEGRATED

Innovative technology meets elegant product design

CONTENT

| | |
|----|-----------------------------------|
| 6 | WHAT IS WASHLET™? |
| 8 | TOTO CLEANOVATION / CLEAN SYNERGY |
| 10 | HISTORY OF WASHLET™ |

12 PRODUCT WORLD OF WASHLET™

| | |
|----|--------------------------|
| 12 | OVERVIEW OF WASHLET™ |
| 14 | NEOREST WASHLET™ AC 2.0* |
| 16 | NEOREST WASHLET™ EW 2.0 |
| 18 | WASHLET™ RW |
| 20 | WASHLET™ SW |
| 22 | WASHLET™ RX EWATER+ |
| 24 | WASHLET™ SX EWATER+ |
| 26 | WASHLET™ RG / RG Lite |

WASHLET™

28 EXPERIENCE & DETAILS

| | |
|----|-----------------------------------|
| 30 | WELLNESS |
| 32 | CLEANLINESS |
| 44 | COMFORT |
| 46 | SUSTAINABILITY |
| 48 | DESIGN |
| 50 | OVERVIEW OF FUNCTIONS OF WASHLET™ |
| 52 | OVERVIEW OF TECHNICAL DETAILS |
| 52 | WC / WASHLET™ COMBINATIONS |
| 54 | PLANNING DATA |
| 57 | WHAT YOU SHOULD KNOW |
| 58 | ABOUT TOTO |
| 60 | IMPRINT |

* NEOREST WASHLET™ AC 2.0 is not available for the UK market.

Let's wash with
TOTO :
WASHLET



CLEAN SYNERGY

Technology and design



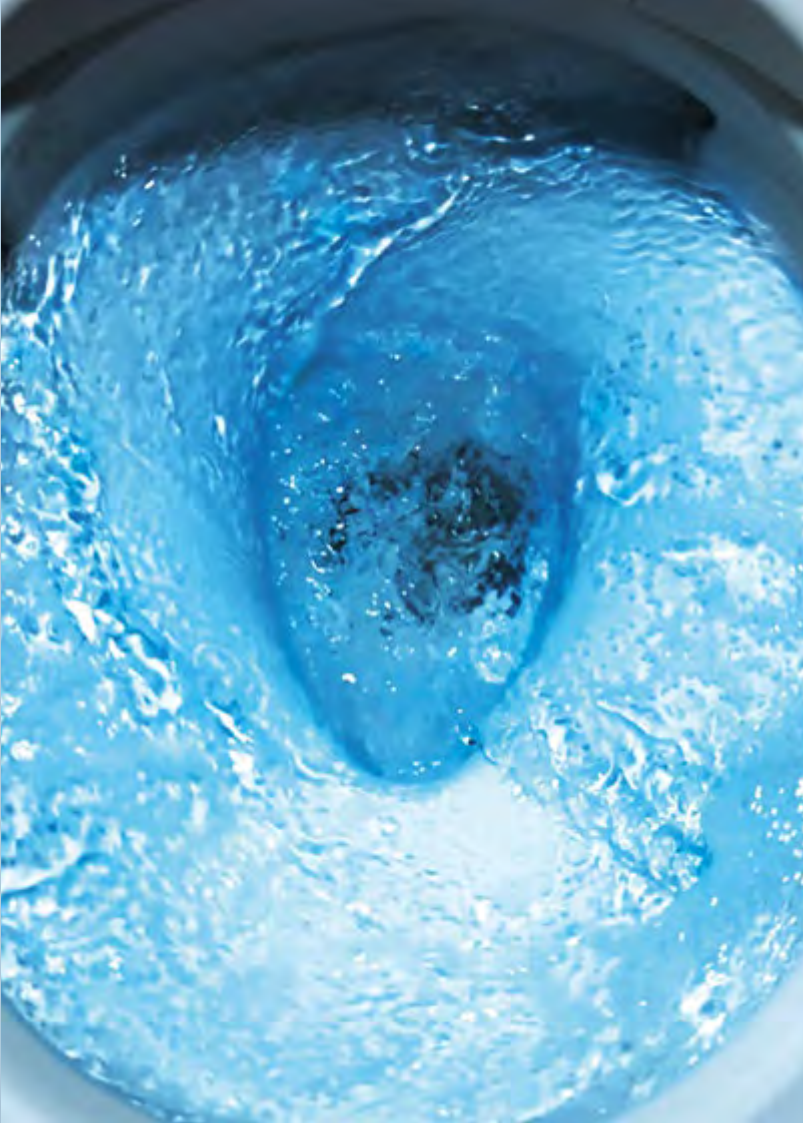



WASHLET®

Life-changing! This is how people describe the experience of using WASHLET™ for the first time. Once they've encountered the soothing comfort of being cleansed with a hygienic stream of water, using just toilet paper will never seem thorough enough.

What is the difference between a standard toilet and WASHLET™?

A WASHLET™ is a shower toilet with an integrated wand jet that cleans the intimate areas with warm water.

A remote control makes it possible to select various functions and individual settings, like the position and water pressure of the spray, as well as the temperature. Other comfort features include a pre-warmed toilet seat and, depending on the model, a dryer.

Who is WASHLET™ made for?

Hygiene isn't a question of age, living conditions or origin. Everyone has their own standards of hygiene – and they get more important when the most intimate parts of the body are involved. As such, a shower toilet is perfect for anyone who cares deeply about personal hygiene and wants to feel fresh throughout the entire day.



Why is WASHLET™ the better choice?

Whether our hands, face or body – we always use water on our skin to ensure the best hygiene. Why not do the same when using the toilet? WASHLET™ models clean the intimate areas gently and naturally with warm water – for a pleasant, fresh feeling any time of the day.

A shower toilet provides many benefits:

- maximum hygiene
- greater well-being
- improved health
- space-saving, modern toilet
- ensures independence in old age or with limited mobility

From a simple toilet

to WASHLET™ – quick and easy

It's easy to add WASHLET™ to transform a TOTO toilet into a modern shower toilet. Talk to your plumber about the necessary power and water connection and other requirements. Depending on your situation, you may be able to switch from paper to gentle cleansing with water in just a day.

TOTO CLEANOVATION

Clean gives peace of mind

Clean makes life beautiful

Clean feels refreshing

Clean is caring for people and the planet

Clean brings wellness to everyday life

TOTO innovation brings a new world of clean to life,
enriching every moment of every day.



EWATER+ for wand
suppresses the accumulation
of waste on wand



EWATER+ for bowl
suppresses the accumulation
of waste on bowl



CLEAN SYNERGY

Your toilet reappears
clean anew every time



CEFIONTECT
forces waste
to slide down



PREMIST
prevents waste
from clinging

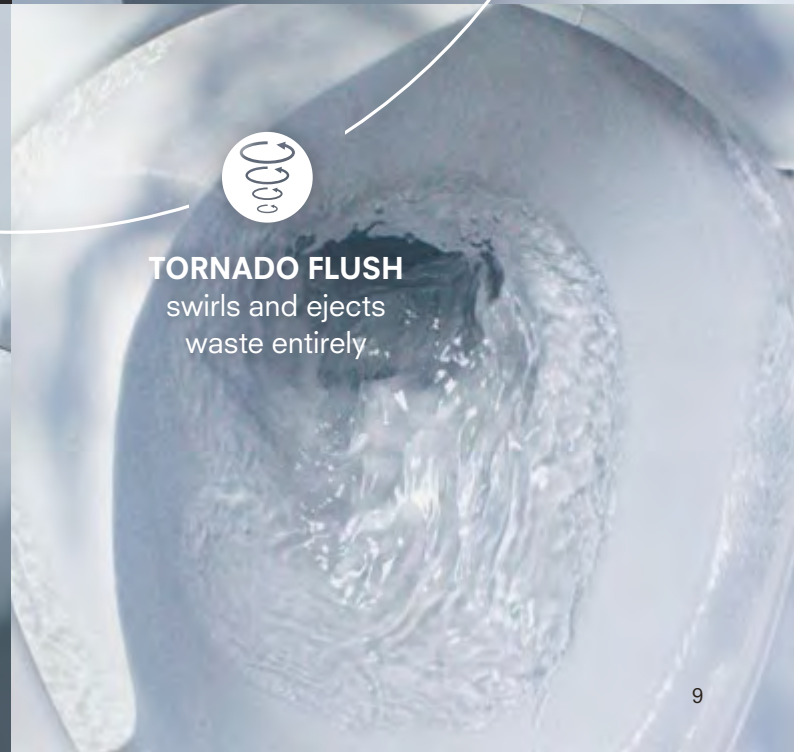

TORNADO FLUSH
swirls and ejects
waste entirely

TOTO.
WASHLET®

50
MILLION

UNITS SOLD
WORLDWIDE

The Birth of a Revolutionary Product



1980

Always Innovating to Spread a Culture of Everyday Comfort and Cleanliness.

Since its launch in the 1980s, WASHLET™ has continually evolved through the invention of countless innovative clean technologies. This is also our history of creating – and spreading around the world – a new culture of comfort and cleanliness through the shift from only wiping with toilet paper to cleansing with water. As a result of these efforts, in 2017 WASHLET™ was recognized as the No. 1

brand of electric toilet seats with bidet function in the world and in 2019 broke through the milestone of fifty million total units sold. As a worldwide best seller, TOTO will continue pursuing technological innovation to make the lives of people everywhere fresher and richer.



**Exceeds
20 million
units**

2005



**Exceeds
40 million
units**

2015

2019

1998



**Exceeds
10 million
units**

2011



**Exceeds
30 million
units**



**Exceeds
50 million
units**

Note 1: EUROMONITOR INTERNATIONAL. Headquartered in London. Global leader in market surveys with experts in 100 countries.

Note 2: "WASHLET is the world's No.1 brand of electric toilet seats with bidet functions in 2017"

Footnote: Source: Euromonitor International Limited; in terms of sales volume, based on the custom research conducted in July 2018 – September 2018 in the countries that account for more than 87 % share of the global electric toilet seats with bidet functions in 2017.

Overview of WASHLET™

NEOREST AC 2.0*

The ultimate solution
for total hygiene
& comfort.



- ▶ Self-cleaning ACTILIGHT function p. 42
- ▶ Individually adjustable wand jet p. 30
- ▶ EWATER+ for the wand p. 32
- ▶ EWATER+ for the bowl p. 34
- ▶ Mist of water prior to use p. 40
- ▶ Sensor-activated lid and flush p. 45
- ▶ Heated seat p. 45
- ▶ Dryer p. 45
- ▶ Filter p. 45
- ▶ Energy saver timer + auto p. 47
- ▶ Decalcifying function p. 47

NEOREST EW 2.0

The ultimate solution
with added hygiene
& comfort.



- ▶ Individually adjustable wand jet p. 30
- ▶ EWATER+ for the wand p. 32
- ▶ EWATER+ for the bowl p. 34
- ▶ Mist of water prior to use p. 40
- ▶ Sensor-activated lid and flush p. 45
- ▶ Heated seat p. 45
- ▶ Dryer p. 45
- ▶ Filter p. 45
- ▶ Energy saver timer + auto p. 47
- ▶ Decalcifying function p. 47

RW

Hygiene and design
in a curved design.



- ▶ Individually adjustable wand jet p. 30
- ▶ EWATER+ for the wand p. 32
- ▶ EWATER+ for the bowl p. 34
- ▶ Mist of water prior to use p. 40
- ▶ Clean Case p. 41
- ▶ Seamless seat p. 41
- ▶ Sensor-activated lid p. 45
- ▶ Heated seat p. 45
- ▶ Dryer p. 45
- ▶ Filter p. 45
- ▶ Energy saver timer + auto p. 47
- ▶ Decalcifying function p. 47

SW

Hygiene and design
in an angular design.



- ▶ Individually adjustable wand jet p. 30
- ▶ EWATER+ for the wand p. 32
- ▶ EWATER+ for the bowl p. 34
- ▶ Mist of water prior to use p. 40
- ▶ Clean Case p. 41
- ▶ Seamless seat p. 41
- ▶ Sensor-activated lid p. 45
- ▶ Heated seat p. 45
- ▶ Dryer p. 45
- ▶ Filter p. 45
- ▶ Energy saver timer + auto p. 47
- ▶ Decalcifying function p. 47

*NEOREST WASHLET™ AC 2.0 is not available for the UK market.

RX EWATER+

A minimalistic, curved design option.



- ▶ Individually adjustable wand jet p. 30
- ▶ EWATER+ for the wand p. 32
- ▶ Mist of water prior to use p. 40
- ▶ Clean Case p. 41
- ▶ Heated seat p. 45
- ▶ Filter p. 45
- ▶ Energy saver timer + auto p. 47
- ▶ Decalcifying function p. 47

SX EWATER+

A simple, angular design option.



- ▶ Individually adjustable wand jet p. 30
- ▶ EWATER+ for the wand p. 32
- ▶ Mist of water prior to use p. 40
- ▶ Clean Case p. 41
- ▶ Heated seat p. 45
- ▶ Filter p. 45
- ▶ Energy saver timer + auto p. 47
- ▶ Decalcifying function p. 47

RG / RG Lite

Overall hygiene in a compact design.



- ▶ Individually adjustable wand jet p. 32
- ▶ EWATER+ for the wand p. 34
- ▶ PREMIST*: Mist of water prior to use p. 42
- ▶ Clean Case p. 43
- ▶ Seamless seat p. 43
- ▶ Heated seat p. 47
- ▶ Filter* p. 47
- ▶ Energy saver timer + auto p. 48
- ▶ Decalcifying function p. 47

* WASHLET™ RG only



NEOREST WASHLET™ AC 2.0*

The NEOREST collection contains TOTO's flagship products, which feature the most extensive comfort and hygiene functions. The NEOREST WASHLET™ is available in two identical designs: EW 2.0 (with EWATER+ technology) and AC 2.0* (with additional ACTILIGHT technology).

NEOREST WASHLET™ AC 2.0* is TOTO's first self-cleaning toilet. ACTILIGHT actively breaks down waste and bacteria using a combination of UV light and zirconium coating. The electrolysed EWATER+ also cleans the toilet bowl and WASHLET™ wand jet after use, and keeps waste and dirt from accumulating. Before using the toilet, the PREMIST function sprays the toilet bowl with a fine mist of water to make it more difficult for dirt and bacteria to stick to the surface.

The NEOREST AC 2.0* also has a sensor-activated lid which opens and closes by itself, an automatic flush and an adjustable dryer. The heated seat and deodoriser ensure that your visit to the bathroom is more pleasant. The wand jet system for personal cleansing is, of course, individually adjustable.

Of course, the NEOREST AC 2.0* toilet seat isn't kept heated at all times. Energy Saver Auto records user preferences for 10 days and automatically sets them.

The water for the intimate cleansing feature on NEOREST WASHLET™ is heated by a continuous-flow water heater – for unlimited warm water.

-
- ▶ Technologies p. 50
 - ▶ Planning data p. 54



* NEOREST WASHLET™ AC 2.0 is not available for the UK market.



NEOREST WASHLET™ EW 2.0

The NEOREST EW 2.0 is basically identical to the NEOREST AC 2.0* – the only difference is that the EW 2.0 does not feature the self-cleaning ACTILIGHT technology.

Before use, the NEOREST EW 2.0 sprays the inside of the toilet bowl with water (PREMIST) – after all, less waste will stick to a wet surface. Once the toilet is flushed, WASHLET™ automatically sprays the toilet bowl as well as the wand jet with electrolysed water. EWATER+ has a cleansing effect and keeps waste from accumulating.

Like the NEOREST AC 2.0, the EW 2.0 has a sensor-activated lid which opens and closes by itself, an automatic flush and an adjustable dryer. The heated seat and deodoriser ensure that your visit to the bathroom is more pleasant. The wand jet system for personal cleansing is, of course, individually adjustable. All the functions, including the water jet temperature, pressure and position, can be conveniently adjusted using the remote control.

Of course, the NEOREST EW 2.0 toilet seat isn't kept heated at all times. Energy Saver Auto records user preferences for 10 days and automatically sets them.

► Technologies p. 50

► Planning data p. 54





WASHLET™ RW

WASHLET™ RW is the Prime Edition of TOTO and has more to offer than just its slim profile: It is equipped with many of TOTO's well-known hygiene features, and even includes a new one.

The seamless seat ring on the RW is even easier to clean. It's also possible to easily remove WASHLET™ from the toilet bowl for thorough cleaning. A silicone-based material is used for WASHLET™ itself (so-called "Clean Case"), which makes it more difficult for dirt to accumulate.

Of course, WASHLET™ RW comes equipped with all of the characteristic hygiene and comfort features: warm water spray, heated seat, odour-absorbing deodoriser and dryer. In addition, the EWATER+ feature cleans WASHLET™ wand jet and the toilet bowl with electrolysed water after use.

-
- ▶ Technologies p. 50
 - ▶ Planning data p. 54



WASHLET™ SW

The SW is TOTO's next Prime Edition model. It includes the same features as the curved RW. The only difference between the two models is their design.

In addition to the well-known hygiene and comfort features, WASHLET™ SW also has a seamless seat which makes it even easier to clean. It's also possible to easily remove WASHLET™ from the toilet for thorough cleaning. A silicone-based material is used for WASHLET™ itself (so-called „Clean Case“), which makes it more difficult for dirt to accumulate.

Of course, WASHLET™ SW is equipped with all of the characteristic hygiene and comfort features: warm water spray, heated seat, odour-absorbing deodoriser and dryer. In addition, the EWATER+ feature cleans the wand jet and toilet bowl with electrolysed water after use.

- ▶ Technologies p. 50
- ▶ Planning data p. 54



GREEN
GOOD DESIGN
AWARD
2018



DESIGN
AWARD
2020





WASHLET™ RX EWATER+

WASHLET™ RX EWATER+ combines elegant design, featuring an exclusive urea resin seat, with TOTO's consistently high standards of hygiene.

The RX EWATER+ model also includes an adjustable warm water spray, which is heated by a continuous-flow water heater to ensure unlimited warm-water cleansing. It also has a heated seat, odour-absorbing deodoriser and the PREMIST feature, which automatically sprays a fine mist of water onto the toilet bowl before use. This helps wash away anything that might stick to the surface. The wand jet automatically cleans itself after every use with dirt-repellent EWATER+.

Like all WASHLET™ models, it's possible to save preferred spray settings for two users on the remote control and access them at the touch of a button.

- ▶ Technologies p. 50
- ▶ Planning data p. 54



GREEN
GOOD DESIGN
AWARD
2018



DESIGN
AWARD
2019



WASHLET™ SX EWATER+

WASHLET™ SX EWATER+ has the same features as the RX EWATER+. The only difference is the shape. The angular WASHLET™ SX EWATER+ has an elegant, slim urea resin seat and is equipped with TOTO's proven technologies.

The SX EWATER+ includes the familiar comfort and hygiene features TOTO is known for: the heated seat, adjustable warm water spray (with continuous-flow water heater for unlimited cleansing), odour-absorbing deodoriser and PREMIST function. The SX EWATER+ also uses the cleansing EWATER+ feature to automatically clean the wand jet after each use.

Like all WASHLET™ models, it's possible to save preferred spray settings for two users on the remote control and access them at the touch of a button. .

► Technologies p. 50

► Planning data p. 54







WASHLET™ RG / RG Lite

This WASHLET™ is available in the variants RG and RG Lite. The two versions are identical in design and simply differ in the extent of technologies. With a depth of 540 mm these two WASHLET™ models are compact enough to fit even in smaller bathrooms.

The RG Lite is available with hidden and side connections and can be combined with a wide range of TOTO WCs in the version with side connections.

Of course, the user of the RG Lite can also rely on TOTO's extensive hygiene technologies. The heated seat and the individually adjustable water nozzle offer the user comfort and a long-lasting feeling of freshness. And to be protected from dirt, the WASHLET™ nozzle is also positioned behind a flap above the WC ceramics in this model. Furthermore, the automatic pre-cleaning of the nozzle with water and the post-cleaning with EWATER+ ensures optimal hygiene for every user.

The WASHLET™ RG additionally features the PREMIST function, which sprays the WC ceramics with a fine mist of water before use. Also integrated is a deodoriser that filters unpleasant odours.

- ▶ Technologies p. 50
- ▶ Possible combinations p. 52
- ▶ Planning data p. 56



GREEN
GOOD DESIGN
AWARD
2018



**Every moment of every day,
the experience of life arising clean,
comfortable and always inviting.**

Constantly at work, automated technologies maintain hygienic conditions, keeping surfaces clean and providing a place that is inviting and comfortable.





WARM WATER NOZZLE

The precise, adjustable, stream keeps you clean. And it's always pleasantly warm.

Users can choose from more than just the Comfort and Front wash sprays. Additional functions allow users to personalise their cleansing experience. The focus is always on the gentle, comfortable spray that uses as little water as possible.

Cleansing spray patterns

Rear Cleansing



Large air-filled water droplets offer complete cleansing and a comfortable sensation with minimal water use.

Rear Soft Cleansing



Plentiful shower of water gives a gentle sensation for complete cleansing over a wider area.

Front Cleansing



Gentle dispersion of large water droplets ensure intimate cleansing in the most comforting way.

Additional functions

Oscillating



The back-and-forth movement of the wand ensures thorough cleansing of the entire area.

Pulsating



The selected spray pattern is switched to pulsing mode.

Wand Position Adjustment



It's easy to adjust the position of the wand jet to your individual needs.

Water Pressure Adjustment



Select from five levels of water pressure.



EWATER+ for the wand

CLEAN SYNERGY

**Suppresses the
accumulation of waste
on wand**

The wand washes itself
inside and out with
EWATER+ to maintain
hygienic conditions.

After each use, the WASHLET™ wand automatically washes itself with EWATER+. This thorough cleaning occurs inside the wand as well as all around the exterior. Even when the toilet is not being used, the wand periodically cleans itself to ensure constant hygienic conditions.

Long lasting Cleaniness



Survey: Study the effectiveness of EWATER+ by comparing the state of cleanliness of wands self-cleaned with EWATER+ versus those that are not. No additional cleaning was allowed. Survey period: Two months (September–October 2017). Subjects: Families of four. (Results vary according to usage, environmental conditions, and product type. All data collected by TOTO.)

Always keeping Conditions clean

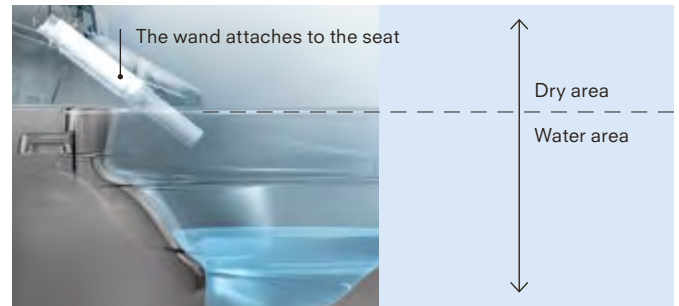

Made of high-quality waste-resistant resin and automatically sprayed with EWATER+ after each use, the wand is extremely resistant to waste and stains. What's more, the wand attaches to the seat, not the bowl, so waste is less likely to even reach it. Though the wand is self-cleaning, you will appreciate how easily you can reach it and wipe it spotless.

Self-cleaning, even inside the wand jet

Before use



During use



After use



During standby



Self-cleans with water



Self-cleans with water



Self-cleans inside and out with EWATER+



Self-cleans inside with EWATER+



EWATER+ for the bowl

CLEAN SYNERGY

**Suppresses the
accumulation of waste
on wand**

Electrolyzed water
reduces waste, even
bacteria you can't see.

EWATER+ washes the wand and toilet bowl where waste and bacteria tend to accumulate and produce stains that can become permanent. Using no chemicals or cleaning agents, EWATER+ provides peace of mind every day that microscopic bacteria has no place to hide.

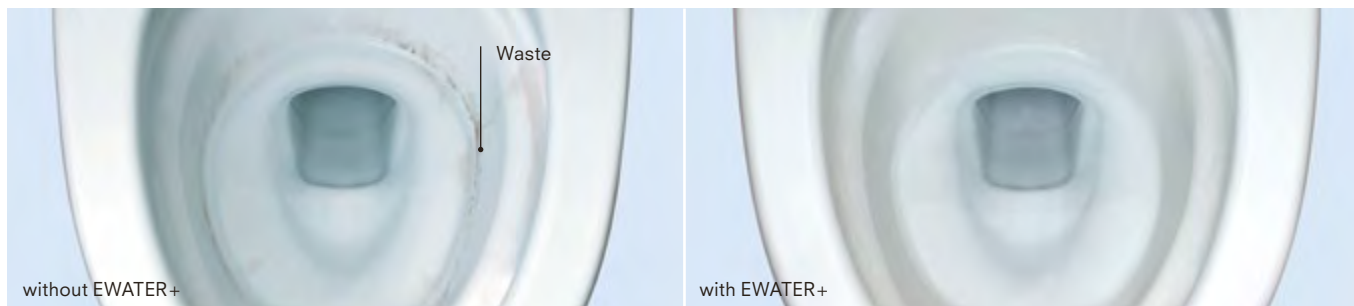

Survey: Study the effectiveness of EWATER+ by comparing the state of cleanliness of toilet bowls that receive no cleaning versus toilet bowls that are self-cleaned with EWATER+. No additional cleaning was allowed.

Survey period: One month (February–March 2017).
Subjects: Families of four. (Results vary according to usage and environmental conditions. All data collected by TOTO.)

How EWATER+ cleans

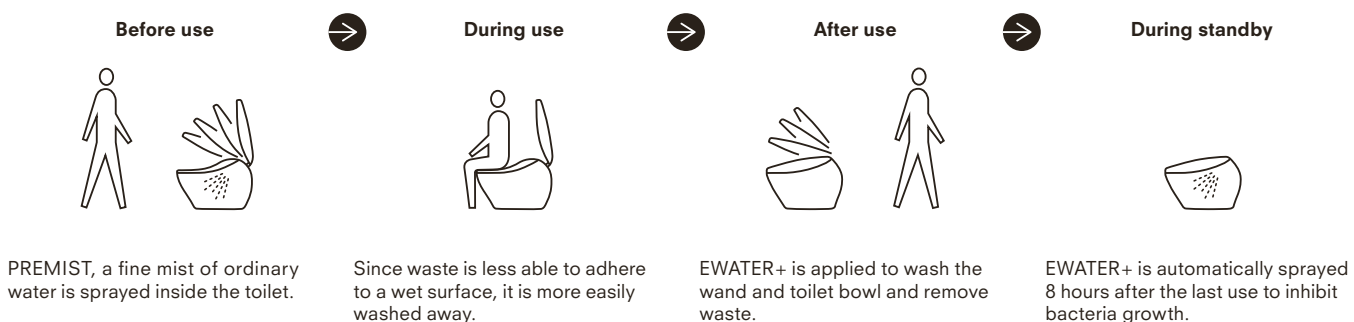

What is EWATER+?

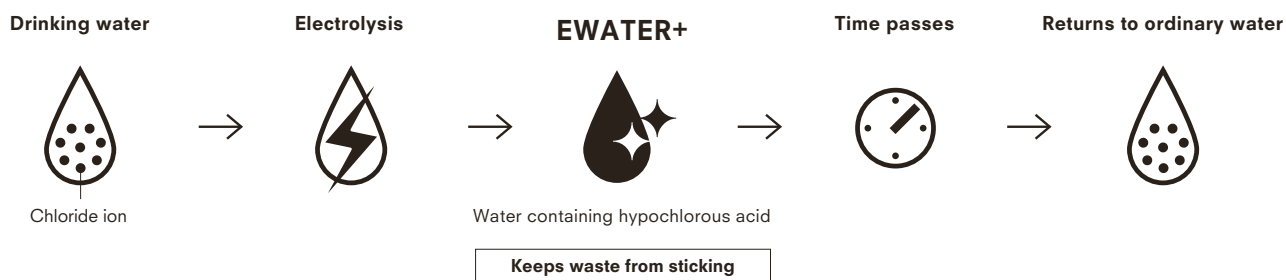

Produced by electrolysis of the chloride ion in drinking water, it is completely free of chemicals and cleaning agents.

Over time EWATER+ returns to its original state of ordinary water, making it completely environmentally friendly.



CEFIONTECT

CLEAN SYNERGY

**Forces waste
to slide down**

Ultra-smooth ceramic
leaves nowhere
for waste to cling.

CEFIONTECT is an ultra-smooth ceramic glaze that coats the toilet bowl. Its microscopic surface ridges are far smaller than waste particles, leaving no place for waste to gain a foothold. Extremely durable, CEFIONTECT is designed for enduring beauty and cleanliness.

Extremely smooth glaze

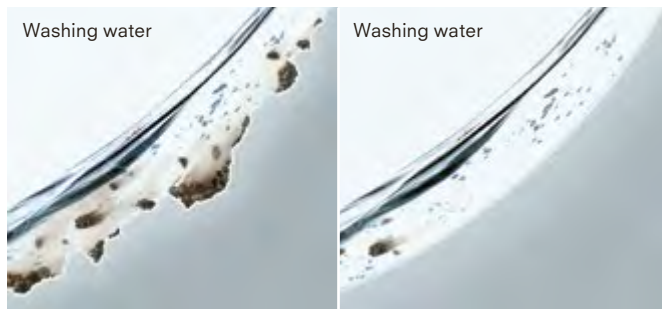

No CEFIONTECT

CEFIONTECT

Conventional ceramic may appear perfectly smooth to the eyes, but has gaps where waste, mold and bacteria hide. At just one millionth of a millimeter, CEFIONTECT's surface ridges are much tinier than waste particles.

CEFIONTECT is hydrophilic



Water hydrophobic

Water hydrophilic

Hydrophilic describes organisms and materials that attract water. CEFIONTECT is hydrophilic. Water spreads easily over the toilet bowl, so waste particles easily wash away.

What makes CEFIONTECT so durable?

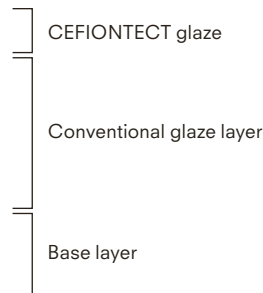

CEFIONTECT toilet micrograph * 1 μm=0.001 mm

Glass layers are burned onto conventional glaze, making CEFIONTECT an extremely durable material.



TORNADO FLUSH

CLEAN SYNERGY

**Swirls and ejects
waste entirely**

360° cleaning power
reaches every spot
using less water.

TORNADO FLUSH cleans more effectively – but is also quieter, and uses less water than conventional toilets. The powerful flush creates a whirlpool that cleans every inch of the toilet bowl without missing a spot.



TORNADO FLUSH

Powerful flush for thorough cleanliness



TORNADO FLUSH reaches every inch of the toilet bowl – all the way to the edge. The water is propelled into the bowl, creating a whirlpool that harnesses the power of the water for thorough cleansing. The high-quality ceramic used in TOTO toilets make this innovative technology possible.



RIMLESS

Rimless ceramic toilet bowls



The RIMLESS design not only leaves no place for waste and germs to hide. It also makes for a much easier to clean toilet.

Hygiene, setting new standards.

Hygiene report

TOTO commissioned a comparative study* of a conventional toilet and the TOTO toilets with TORNADO FLUSH. The results showed that these TOTO toilets are especially suitable for use in hygiene-critical areas, such as hospitals, care facilities and heavily used toilets. Another finding showed that the TORNADO FLUSH on the rimless TOTO toilet eliminated all waste and organisms from the surface with the very first flush. To read the complete report, go to: <http://gb.toto.com>

Excerpt from report

“It was possible to thoroughly clean the ceramic surface and eliminate all soiled areas on the ceramic surfaces of the TOTO toilets quickly, easily and without great effort.

For this reason, only very little time is needed for cleaning.”
 “... The TOTO CW762Y and CW132Y rimless toilets [...] are superior to the conventional toilet with rim and standard flush.”

Prof. Dr. med. Klaus-Dieter Zastrow
 Doctor for hygiene and environmental medicine

SBZ Flush test Winner

SBZ magazine teamed up with the Esslingen University of Applied Sciences to test the flush attributes of toilets from all prominent manufacturers. TOTO ranked first with all of its models, with the SG 2.0 toilet earning the highest marks in the test overall. The TOTO toilets all had outstanding flush characteristics and do not produce any spray when installed accordingly.



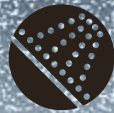

PREMIST

CLEAN SYNERGY

**Prevents waste
from clinging**

A film of water
keeps waste
from clinging.

PREMIST automatically sprays water over the surface of the inner toilet bowl before every use. Due to the ceramic's hydrophilic nature, waste washes away more easily.

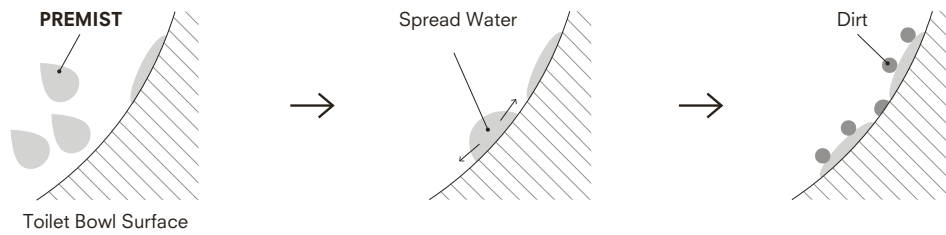

Guaranteed cleanliness

Covered wand jet



The wand jet disappears completely under a hygienic flap, keeping it free of faeces and urine.

Wand jet position

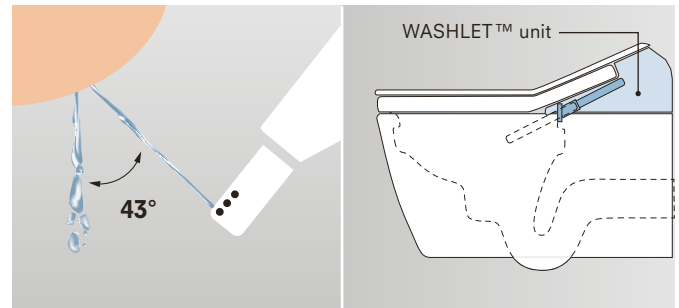

The jet extends at an angle, which keeps it from getting dirty. The soiled water falls directly into the toilet bowl at an angle of 43–53°, which keeps the jet clean.

Clean resin for nozzle

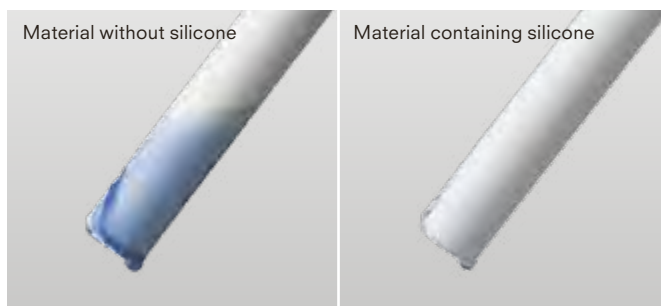

The wand jet is coated with a silicone-based material with dirt-resistant properties, which keep the jet clean in combination with its self-cleaning feature.

Clean resin for the toilet seat

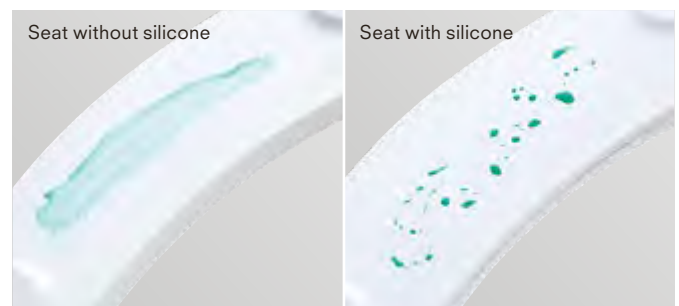

The toilet seat also consists of a special silicone-based material with dirt-resistant properties.

Clean Case – Clean resin for case

Like WASHLET™ seat and nozzle, several WASHLET™ models also feature WASHLET™ unit made of special silicone-based material with dirt-repellent properties.

Seamless toilet seat

While WASHLET™ seat consists of several parts, including the heating coil in the middle, the seat itself is seamless. This gives dirt or waste less space to attack.



ACTILIGHT

Photocatalytic glaze, the ultimate cleaning technology, has the natural power to decompose waste.

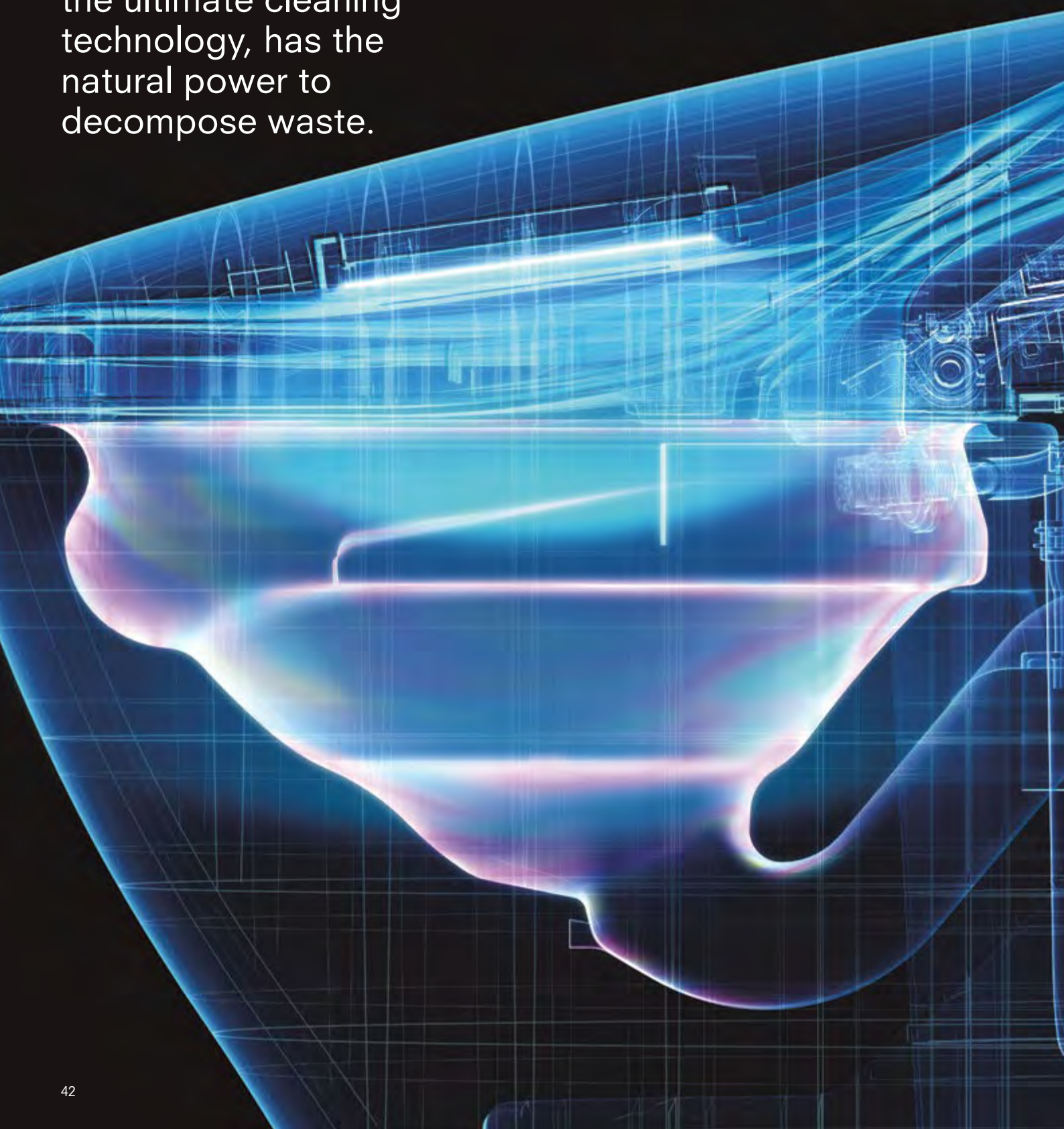

ACTILIGHT in the **NEOREST WASHLET™ AC 2.0*** elevates toilet cleaning to an extraordinary new dimension. Comprising a bacteria-neutralizing ultraviolet light and a titanium dioxide-fired toilet bowl, this extraordinary technology initiates a photocatalytic process that breaks down even microscopic waste particles.

State-of-the-art materials

Titanium dioxide attracts water to the surface of the toilet bowl, setting the stage for photocatalysis. The toilet bowl's photocatalytic glaze layer also contains zirconium oxide, which provides its extreme durability.

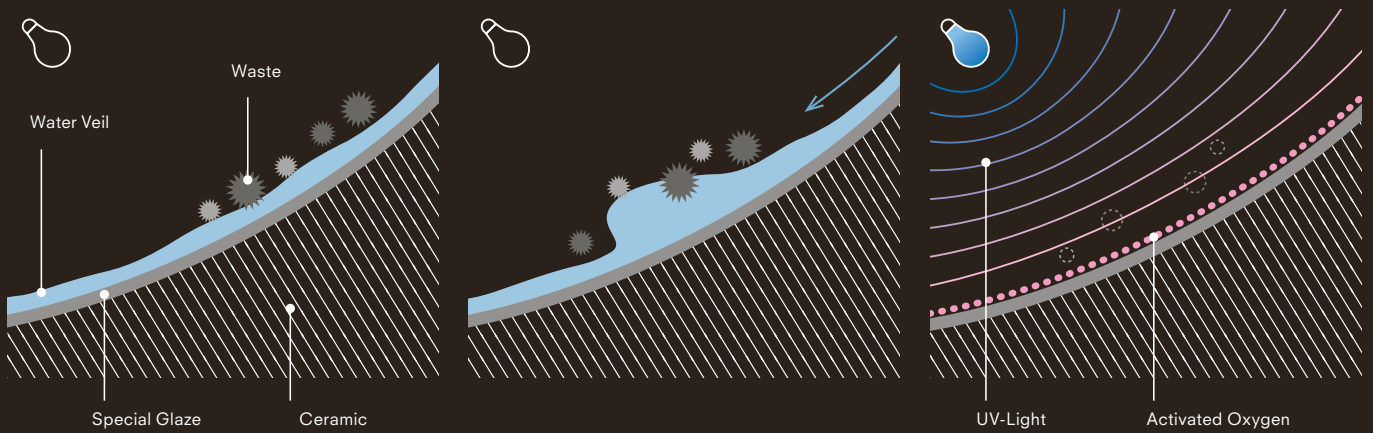

Operates 24 hours a day to maintain hygienic conditions

Before use



During use



After use



During standby



PREMIST, a fine mist of ordinary water is sprayed inside the toilet.



Since waste is less able to adhere to a wet surface, it is more easily washed away.



Automatic flushing, then spraying of EWATER+ to clean the toilet bowl.



The UV light reacts with the titanium dioxide, decomposing waste in the toilet bowl.

*NEOREST WASHLET™ AC 2.0 is not available for the UK market.



WASHLET™ offers the following comfort features for the most user-friendly experience possible.



Sensor-activated lid



Eliminating the need to touch the toilet surfaces, the lid of the WASHLET™ models NEOREST AC 2.0* and EW 2.0, RW and SW automatically opens and closes when the toilet is approached and departed.



Side night lights



Subdued lighting switches on when the WASHLET™ models NEOREST AC 2.0* and EW 2.0, RW and SW are approached, so users do not have to disturb themselves at night with a bright bathroom light.



Heated seat



The remote control regulates the WASHLET™ seat temperature and switches the heated seat on and off. Especially comfortable and beneficial in the winter, the heated seat also has an energy-saving feature.



Deodoriser



Highly effective deodorizing automatically takes place inside the toilet bowl both during and immediately after use, leaving no disturbing odors. Available for all WASHLET™ models besides RG Lite.



Sensor-activated flush



No need to touch buttons or handles and never worry about someone forgetting to flush – it's automatic after each use. Available for the NEOREST AC 2.0* and EW 2.0 model.



Remote control



The remote control makes all functions easy to use and adjust. Several models include a memory function to save preferred settings for up to two users. It is also possible to flush the toilet using the remote control on several models.



Dryer

The individually adjustable dryer follows the warm water spray to ensure a dry, clean overall feeling. Available for the following models: NEOREST AC 2.0* and EW 2.0, RW and SW.



Continuous-flow water heater

All TOTO WASHLET™ feature a continuous-flow water heater to provide unlimited water for intimate cleansing.

* NEOREST WASHLET™ AC 2.0 is not available for the UK market.

ENERGY SAVER

**Save energy
during times
of non-use**

Manual and
automatic
energy saving
feature.



TOTO shower toilets feature two types of energy savers. Energy saver timer allows you to set a time at which the shower toilet is set to stand-by mode. With energy saver auto, it records its users' habits and automatically selects the best time for stand-by mode.

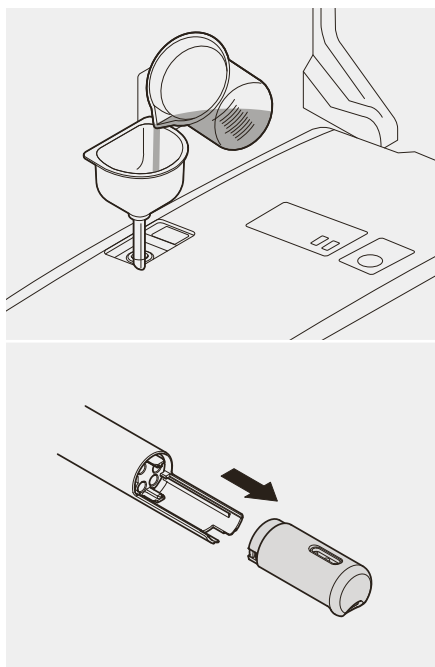

Decalcification

It is possible to decalcify TOTO shower toilets. For the NEOREST WASHLET™ AC 2.0* and EW 2.0 model, simply fill with a TOTO-recommended, conventional decalcifying agent and start the decalcifying programme. And for the RW and SW, RX EWATER+ and SX EWATER+, RG and RG Lite WASHLET™ you can decalcify with the automatic decalcifying programme and the removable wand jet.

EN 1717 standard stands for drinking water safety

Toilet water is rated as a hazard class 5 liquid in accordance with EN 1717. This standard describes the necessary precautions that a device must fulfil in order to secure the quality of drinking water. All TOTO shower toilets are intrinsically safe and have a family A, type B respectively type D backflow prevention. This keeps non-potable water from flowing back into drinking water systems without any additional installation required.

Sustainable cleansing

WASHLET™ models NEOREST AC 2.0* and EW 2.0, RW and SW spray the cleansing EWATER+ onto the extra smooth ceramic toilet bowl to make it more difficult for waste and bacteria to accumulate. Free of chemicals and cleansers, EWATER+ can be released back into the water cycle without worry as H₂O.



All WASHLET™ models are WRAS certified and meet the high standards of UK water regulations. With its environmentally friendly philosophy, this certification also confirms TOTO's sustainable responsibility at a local level.



* NEOREST WASHLET™ AC 2.0 is not available for the UK market.



INTEGRATED

Innovative
technology
meets elegant
product design



WASHLET™ RX EWATER+ with WC RP

WASHLET™ models and toilets unite innovative technologies and aesthetic design.
The goal: to provide users with maximum hygiene and comfort.
The result: a holistic wellness experience for the body and soul.



Product details of TOTO's Prime Edition: WASHLET™ RW with WC RP and WASHLET™ SW with WC SP

Toilet and WASHLET™ combinations that are truly stunning from every angle

TOTO's minimalistic product design is aligned with its technology. All technical components are integrated within the product. You know that they are there, and can use them – but cannot see them. To achieve the best look, we combine most WASHLET™ models with a compatible TOTO toilet that makes it possible to run the needed cable and water connections through the ceramic.

Award-winning design

TOTO and WASHLET™ stand for excellent design as shown by the many prominent product awards received in recent years (excerpt):



Green Good Design Award













NEOREST AC 2.0, NEOREST EW 2.0, RW, SW, RX EWATER+, SX EWATER+, RG, RG Lite





iF Design Award

NEOREST AC 2.0, RX and RW (with WC RP), SX and SW (with WC SP)

Overview of WASHLET™ functions







| | | NEOREST WASHLET™ AC 2.0* | NEOREST WASHLET™ EW 2.0 | |
|-----------|---|---|---|--|
| | |  |  | |
| HYGIENE |  ACTILIGHT | • | | |
| |  EWATER+ for the bowl | • | • | |
| |  EWATER+ for the wand | • | • | |
| |  PREMIST | • | • | |
| |  Self-cleaning wand jet | • | • | |
| |  Clean resin for nozzle  Clean resin for toilet seat | • | • | |
| |  Clean Case: Clean resin for case | | | |
| |  Seamless seat ring | | | |
| |  CEFIONTECT | • | • | |
| |  RIMLESS DESIGN | • | • | |
| |  TORNADO FLUSH | • | • | |
| |  Decalcifying function | • 1) | • 1) | |
| CLEANSING |  Comfort spray rear | • | • | |
| |  Comfort spray rear soft | • | • | |
| |  Comfort spray front wash | • | • | |
| |  Oscillating spray | • | • | |
| |  Massaging spray | • | • | |
| |  Adjustable water pressure | • | • | |
| |  Adjustable position | • | • | |
| COMFORT |  Nightlight | • | • | |
| |  Sensor-activated flush | • | • | |
| |  Sensor-activated lid | • | • | |
| |  Soft-closing seat | • | • | |
| |  Remote control | • | • | |
| |  DRYER with adjustable temperature | • | • | |
| |  HEATED SEAT with adjustable temperature | • | • | |
| |  DEODORISER – Air-cleaning filter system | • | • | |
| |  Memory funktion for two people | • | • | |
| | Continuous-flow water heater | • | • | |
| | Energy Saver Timer | • | • | |
| | Energy Saver Auto | • | • | |

Overview of technical details

| | | NEOREST WASHLET™ AC 2.0* | NEOREST WASHLET™ EW 2.0 | |
|---------------------|--|---|---|--|
| | |  |  | |
| WARM WATER SPRAY | Comfort spray flow rate | 0.27 to 0.43 l/min | 0.27 to 0.43 l/min | |
| | Soft flow rate | 0.27 to 0.43 l/min | 0.27 to 0.43 l/min | |
| | Lady shower flow rate | 0.29 to 0.43 l/min | 0.29 to 0.43 l/min | |
| | Continuous-flow water heater | ● | ● | |
| | Warm water supply | unlimited | unlimited | |
| | Adjustable water temperature | 30 to 40 °C | 30 to 40 °C | |
| COMFORT | Heated seat, individually adjustable temperature | 28 to 36 °C | 28 to 36 °C | |
| | Deodoriser – Filter system performance | 0.16m³/min | 0.16m³/min | |
| | Dryer with adjustable temperature | 35 to 55 °C approx. 0.29m³/min | 35 to 55 °C approx. 0.29m³/min | |
| CONNECTIONS / PIPES | Power outlet required | ● | ● | |
| | Water connection pressure | 1 to 10 bar | 1 to 10 bar | |
| | Power input | 1,289–1,527 W | 1,289–1,527 W | |
| | Connection limits | 220–240 V/50 Hz | 220–240 V/50 Hz | |
| ECO | EN 1717 (Drinking water safety) | ● | ● | |

WC/WASHLET™ combinations

| | | NEOREST WASHLET™ AC 2.0* | NEOREST WASHLET™ EW 2.0 | |
|--------|---|--------------------------|-------------------------|--|
| TOILET | WC NEOREST AC 2.0* with Zirconium coating | ● | | |
| | WC NEOREST EW | | ● | |
| | WC RP | | | |
| | WC SP | | | |
| | WC GP | | | |
| | WC NC | | | |
| | WC ES | | | |

| | WASHLET™ RW | WASHLET™ SW | WASHLET™ RX EWATER+ | WASHLET™ SX EWATER+ | WASHLET™ RG | WASHLET™ RG Lite** |
|--|---|---|---|---|---|---|
| |  |  |  |  |  |  |
| | 0,27 to 0,43l/min | | 0.27 to 0.43 l/min | | 0.27 to 0.43 l/min | |
| | 0,27 to 0,43l/min | | 0.27 to 0.43 l/min | | 0.27 to 0.43 l/min | |
| | 0,29 to 0,43l/min | | 0.29 to 0.43 l/min | | 0.29 to 0.43 l/min | |
| | ● | | ● | | ● | |
| | unlimited | | unlimited | | unlimited | |
| | 30 to 40°C | | 35 to 40°C | | 35 to 40°C | |
| | 28 to 36°C | | 28 to 36°C | | 28 to 36°C | |
| | normal 0,09 m³/min, power 0,16 m³/min | | normal 0,09 m³/min, power 0,16 m³/min | | normal 0,09 m³/min, power 0,16 m³/min | |
| | 37 to 55°C approx. 0,29 m³/min | | | | | |
| | ● | | ● | | ● | |
| | 1 to 10Bar | | 1 to 10bar | | 1 to 10 bar | |
| | 1,455–1,468 W | | 1,437–1,459 W | | 1,482–1,495 W | 1,480–1,494 W |
| | 220–240 V / 50 Hz | | 220–240 V / 50 Hz | | 220–240 V / 50 Hz | |
| | ● | | ● | | ● | |

** with hidden or side connections

| | WASHLET™ RW | WASHLET™ SW | WASHLET™ RX EWATER+ | WASHLET™ SX EWATER+ | WASHLET™ RG | WASHLET™ RG Lite | |
|--|----------------|----------------|------------------------|------------------------|----------------|----------------------------|--------------------------|
| | | | | | | with hidden connections | with side connections |
| | | | | | | | |
| | ● CW542EY | | ● CW542EY | | | | ● CW552Y |
| | | ● CW522EY | | ● CW522EY | | | |
| | | | | | ● CW553EY | ● CW553EY | ● CW553Y |
| | | | | | | | ● CW762Y, CW763Y |
| | | | | | | | ● CW797 |

PLANNING DATA

NEOREST WASHLET™ AC 2.0*
incl. remote control



NEOREST WASHLET™ EW 2.0
incl. remote control



Technical drawings

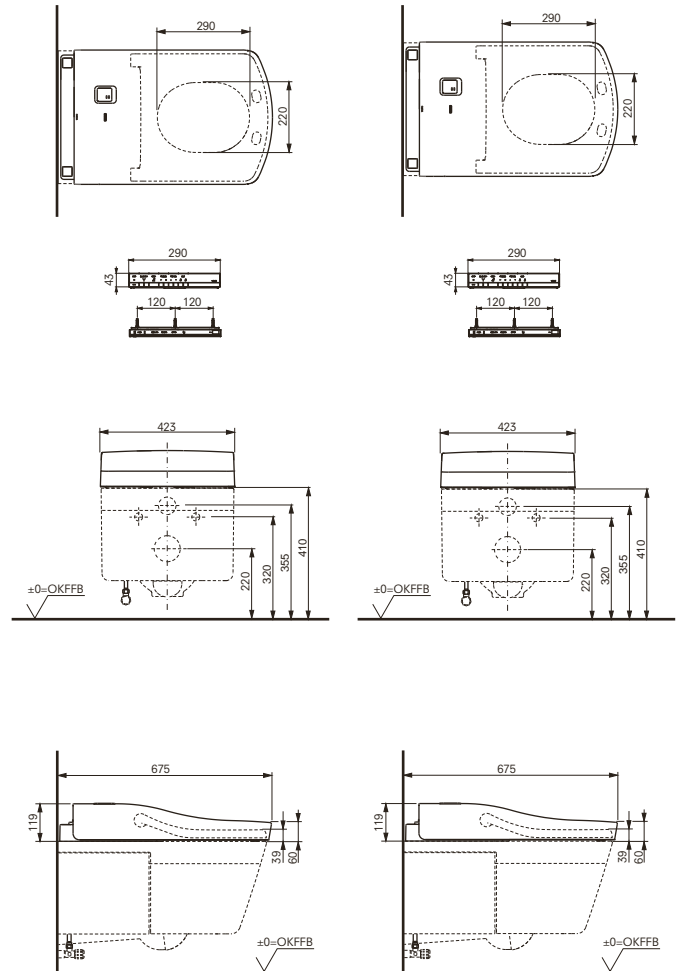

Technologies

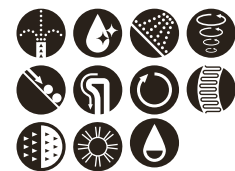

Product code

- ▶ TCF996RWG
- ▶ TCF996RWSW (CH)
- ▶ CW996PVD#NW1 WC
- ▶ TCF996WGE#NW1 (UK)
- ▶ CW996P#NW1 WC (UK)

- ▶ TCF994RWG
- ▶ TCF994RWSW (CH)
- ▶ CW994P#NW1 WC

Required accessories

EU NEOREST WC AC 2.0, wall-hung CW996PVD#NW1, Motor unit for automatic flushing E00004 and TECE NEOREST module 9.300.344, can be combined with NEOREST push plate E00003

UK * NEOREST WASHLET™ AC 2.0 is not available for the UK market.

NEOREST WC EW wall-hung CW994P#NW1, Motor unit for automatic flushing E00004 and TECE NEOREST module 9.300.344, can be combined with NEOREST push plate E00003

NEOREST WC EW, wall-hung CW994P#NW1, Motor unit for automatic flushing E00004, TECE NEOREST module 9.300.048 (1,120 mm) or 9.300.051 (980 mm); can be combined with NEOREST push plate E00003

What you should know

What technical aspects do I need to consider?

Your plumber and electrician need to provide extra power and water connections in advance.

Who can install the shower toilet?

Trained and certified plumbers are fully capable of installing shower toilets.

How can I find the closest plumber or retailer?

You can find retailers and certified plumbers on our website (eu.toto.com).

Can I upgrade my toilet to a shower toilet?

If you have the necessary power and water connections, it is possible to upgrade at any time. Please consult this brochure to see which WASHLET™ models fit on which TOTO toilets.

How can I decalcify WASHLET™?

It's easy to decalcify your own WASHLET™. There are different options available depending on the model. For more details, please see the instructions for your model or our website: eu.toto.com.

Where can I try one?

Use the WASHLET™ finder on our website (eu.toto.com) to see where the nearest publicly accessible WASHLET™ model is located.

Why should I choose a TOTO shower toilet?

TOTO produces the most technically sophisticated shower toilets on the market today.

Our deep feelings for people and their life have remained unchanged since our foundation.

In 1912, in an era when there were as yet no sewage facilities in Japan and thoughts of hygiene were still nascent, Kazuchika Okura, the founder of TOTO, was deeply impressed by the cleanliness of the ceramic toilets he saw in the West, and he took up the challenge to create a national hygienic ceramic

industry based on the idea of “improving the life-style of the Japanese people”. Subsequently, at the end of five years’ research, he succeeded in mass-producing Japan’s first hygienic ceramic toilet. This is exactly what we could call the beginning of a new culture.

TOTO’s manufacturing philosophy is bonded deeply to that moment create when new lifestyle values were created.

Further, these ideas have continued without pause until today.

TOTO remains dedicated to delivering products that offer inclusive functionality and respect for the environment.

We embrace these values every day to create a future that surpasses all expectations.

To ensure we secure and retain the trust of customers and society as a whole, we have formulated a mission with three key elements.



**We will implement our
Global Environmental Vision
to support the mission.**

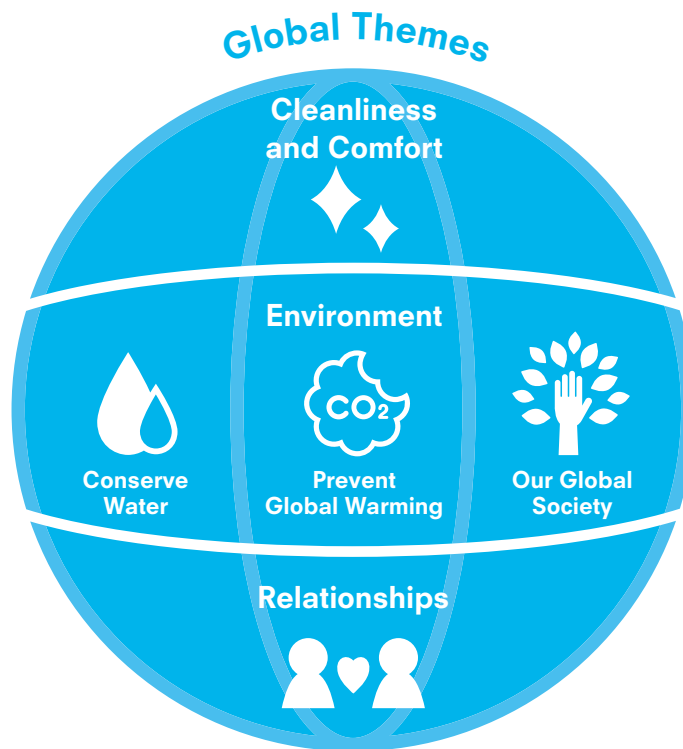

Water, Earth & a better Tomorrow

At TOTO, we're committed to improving life and the environment for a thriving future.

Our production processes and products save water and energy, while reducing impact on the environment.

We provide cleanliness and comfort while building relationships that enrich life.

Water, Earth & a better Tomorrow.

All our group companies are dedicated to building a healthier and more sustainable tomorrow.

Publishing details

Published by
TOTO Europe GmbH

teu.info@toto.com
eu.toto.com

Authorised representatives:
Shinya Tamura, Hiromoto Harano
Managing Director

Copyright
2022, TOTO Europe GmbH
WASHLET and WASHLET logo are trademark
or registered trademark of TOTO Ltd.

Last revised
March 2022

Concept development, editing and design
PLEXGROUP, Berlin
TOTO Europe GmbH

Picture credits
p. 24/25 © iStock/Vladimir Arndt



TOTO Europe GmbH

Headquarters
Zollhof 2
40221 Düsseldorf
Germany

London concept store
(registered in England and Wales
as an overseas company,
number FC029191)
140-142 St. John Street
London EC1V 4UA
United Kingdom
T +44 (0)207 831 7544
teu.london@toto.com

teu.info@toto.com
eu.toto.com